

# INSTRUCTION MANUAL

## BATTERY STORAGE

### TECHNICAL DATA

Battery type	LFP
Rated capacity of battery pack	200Ah
Rated voltage of battery pack	51.2V
Maximum charging voltage	57.6V
Minimum discharge voltage	40V
Rated charge/discharge current	100A
Maximum charge/discharge current	120A
Charging temperature range	0 to +45°C
Discharge temperature range	-20°C to +50°C
Depth of discharge	> 80%
Discharge magnification	< 1C
Self-discharge (25°C)	< 3%/Month
Cycle life	> 5000 times (< 0.5C)
Interactive mode (APP)	LCD+Button+Bluetooth
Dimension	700*515*250mm (Error±2mm)
Weight	About 65KG
Compatible with Solar Inverter [VT-66036103, VT-6605103, VT-12040]	

### INTRODUCTION

Thank you for selecting and buying V-TAC Product. V-TAC will serve you the best. Please read these instructions carefully & keep this user manual handy for future reference. If you have any another query, please contact our dealer or local vendor from whom you have purchased the product. They are trained and ready to serve you at the best.



#### Multi-Language Manual QR CODE

Please scan the QR code to access the manual in multiple languages.

## WARNING

1. Please make sure to turn off the power before starting the installation.
2. Installation must be performed by a qualified electrician.



This marking indicates that this product should not be disposed of with other household wastes.

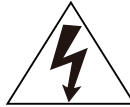

Caution, risk of electric shock.



## CONTROL PANEL

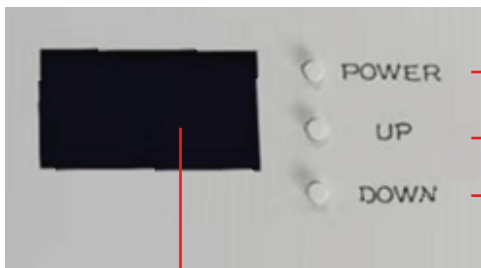

LCD SCREEN

POWER BUTTON

UP BUTTON

DOWN BUTTON

## HUMAN-COMPUTER INTERACTION CONTENT

Project	Function	Remark
Button	POWER	When Powered on: 1. Short press: invalid 2. Long press (press for 4~6 seconds and release): power off  When powered off: 1. Short press: invalid 2. Long press (press for 4~6 seconds and release): turn on
	UP	Page up
	DOWN	Page down
Switch	DC OUTPUT	Use the key to open the front panel before switching on and off

# HUMAN-COMPUTER INTERACTION CONTENT

Project	Function
LCD	<p>There are 6 display interfaces in total:</p> <ol style="list-style-type: none"> <li>1. Main interface information (voltage/current/SOC/status code);</li> <li>2. Secondary main interface information (maximum and minimum cell voltage/maximum and minimum temperature);</li> <li>3. Display 1~4cell voltage;</li> <li>4. Display 5~8cell voltage;</li> <li>5. Display 9~12cell voltage;</li> </ol>
Error code	E11: Level 1 alarm of module equipment failure
	E12: Module equipment failure secondary alarm
	E21: Level 1 alarm of module communication abnormality
	E22: Module communication abnormality secondary alarm
	E31: Module address is abnormal level 1 alarm
	E32: Module Address Abnormal Level 2 Alarm
	E41: Module balancing abnormal level 1 alarm
	E42: Module balance abnormal secondary alarm
	E51: Module total voltage overvoltage level 1 alarm
	E52: Module total voltage overvoltage secondary alarm
	E61: Level 1 alarm of module total voltage undervoltage
	E62: Second-level alarm of module total voltage undervoltage
	E71: Module charging overcurrent level 1 alarm
	E72: Module charging overcurrent secondary alarm
	E81: Module discharge overcurrent level 1 alarm
	E82: Module discharge overcurrent secondary alarm
	E83: Module discharge load short circuit (serious)
	E91: Single battery overvoltage level 1 alarm
	E92: Single battery overvoltage secondary alarm
	E101: Single battery undervoltage level 1 alarm
	E102: Single battery undervoltage secondary alarm
	E111: Module battery high temperature level 1 alarm
E112: Module battery high temperature secondary alarm	
E121: Module battery low temperature level 1 alarm	
E122: Module battery low temperature secondary alarm	

# INTERFACE DEFINITION

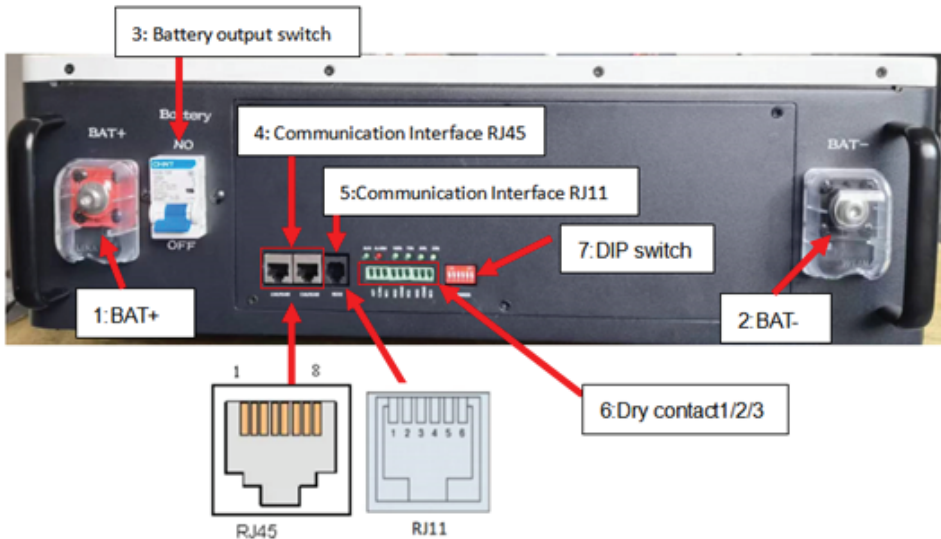

Port	Port type	NO	Signal name	Remark
1,2	Battery output interface	1	BAT+	Battery positive output interface
		2	BAT-	Battery negative output interface
3	Battery output switch	-	Battery	Battery output switch (control positive)
4	Communication Interface (RJ45)	1	CAN-H	CAN bus high level
		2	CAN-L	CAN bus low level
		3	null	null
		4	485-A	RS485-A
		5	485-B	RS485-B
		6	null	null
		7	GT1	communication place
		8	GT1	communication place
5	Communication Interface (RJ11)	1	232-RXD	232 receive signal
		2	232-TXD	232 send signal
		3	GT1	communication place
		4	GT1	communication place
		5	null	null
		6	null	null

Port	Port type	NO	Signal name	Remark
6	Dry contact 1 (3.81 3P Phoenix Terminal)	1	NO1	Dry contact 1
		2	COM1	Dry contact 1 public Terminal
		3	NC1	Dry contact 1 normally closed Terminal
	Dry contact 2 (3.81 3P Phoenix Terminal)	1	NO2	Dry contact 2 normally open Terminal
		2	COM2	Dry contact 2 public Terminal
		3	NC2	Dry contact 2 normally closed Terminal
	Dry contact 3 (3.81 3P Phoenix Terminal)	1	NO3	Dry contact 3 normally open Terminal
		2	COM3	Dry contact 3 public Terminal
		3	NC3	Dry contact 3 normally closed Terminal
7	DIP switch	-	ADDRESS	Binary dial mode

## INSTALLATION

1. Refer to the figure below to install the battery module, the fixing feet are on the ground, the module body is fixed on the wall, and the screws are 4~6mm combination screws. The reference tightening torque is 35 N.m. (unit mm)

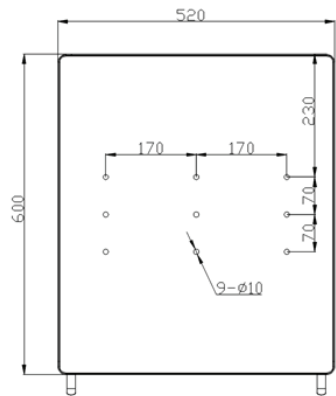

2) Check whether the battery module is firm and safe. (Avoid damp, rain, and direct sunlight as much as possible)

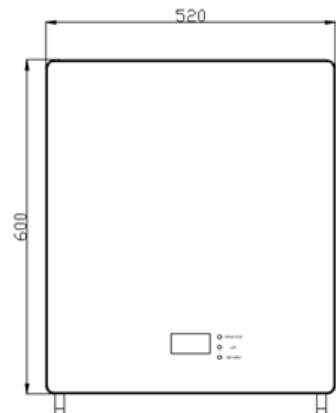
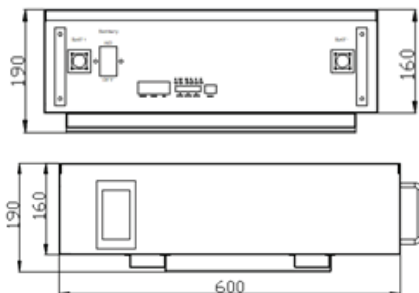

## APP INSTALLATION

Step 1: Scan the given QR code to download App then install the app.

Step 2: After the installation is complete, open the phone settings - application settings - authorization management, and authorize the Bluetooth and positioning of this APP.

Step 3: Open the software and click "BLE" to connect to Bluetooth

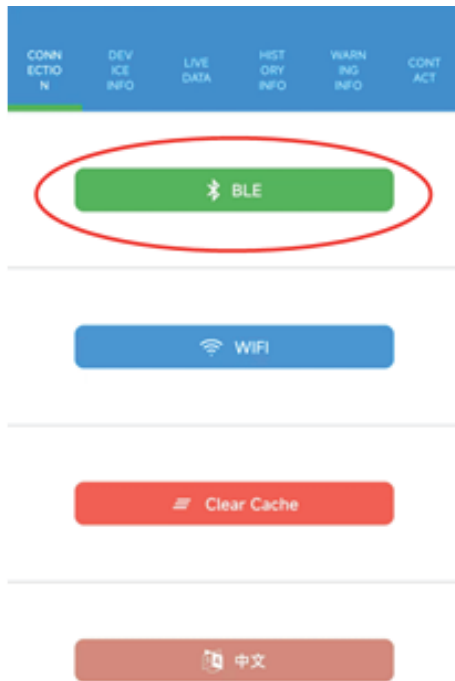

For ANDROID



For IOS



Step 4: Click "Scan Devices" to scan the machine, find the device starting with "AT" and Click "connect" to connect.



Step 5: After successfully pairing the device with the app, you can start reading the relevant data, including "CONNECTION, DEVICE INFO, LIVE DATA, HISTORY INFO, WARNING INFO, CONTACT" to switch (See the below pic).

CONNECTION    DEVICE INFO    LIVE DATA    HISTORY INFO    WARNING INFO    CONTACT

ATH-20220001

NO. Model	00000000
Serial	20220001
Rated V	51.20V
Rated Cap	200.0 AH
Version	43.43.0

CONNECTION    DEVICE INFO    LIVE DATA    HISTORY INFO    WARNING INFO    CONTACT

CONNECTION    DEVICE INFO    LIVE DATA    HISTORY INFO    WARNING INFO    CONTACT

Mon Sep 5 20:37:56 2022

SOC  
91%

SOH  
100%

Total V

54.66 V

Cycles

0

Current

49.7 A

Cell Voltage

1 3.413 V	2 3.429 V	3 3.428 V	4 3.418 V
5 3.413 V	6 3.413 V	7 3.440 V	8 3.410 V
9 3.410 V	10 3.399 V	11 3.406 V	12 3.407 V

CONNECTION    DEVICE INFO    LIVE DATA    HISTORY INFO    WARNING INFO    CONTACT

Date ▼ Device ▼

History Info: ✕

Not Information To Show

Not Information To Show