

INDOOR RECESSED MOUNT PIR DETECTOR

AP-360B

AP-20NB

360-degree PIR

- AP-360B(C) Wired Model
- AP-360BR(C) Battery Operated Model

Curtain PIR

- AP-20NB(C) Wired Model
- AP-20NBR(C) Battery Operated Model

Battery Operated Models are available at limited regions

The AP-360B/20NB is a series of recessed mount indoor PIR detectors. AP-360B provides a 360-degree volumetric detection area. AP-20NB provides a 20 ft. (6m) curtain area. These detectors can offer low profile installation for various application scenes.

Features

- ▶ Compact and Discreet design
- ▶ Detection Sensitivity : High, Medium, Low
- ▶ Tamper function
- ▶ Light Control Option (AP-360B only)
- ▶ Battery Saving Timer (Battery Operated Models only)

Spot Detection Patterns (Ceiling or Wall Mount)

[Ceiling Mount]

360-degree volumetric detection area

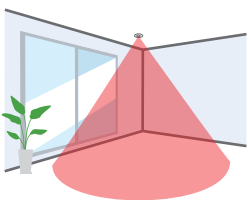

AP-360B/360BR

[Ceiling Mount]

Curtain detection area

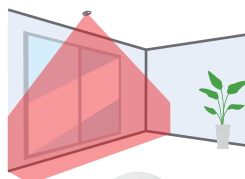

AP-20N/20BR
[Lens Direction : Vertical]

[Wall Mount]

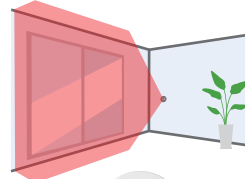

AP-20N/20BR
[Lens Direction : Horizontal]

Plane detection area

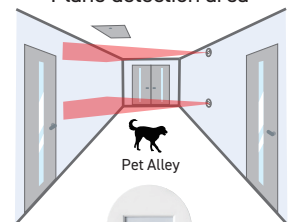

AP-20N/20BR
[Lens Direction : Vertical]

Recessed or 86-type box mount installation

Recessed Mount

The detector can be installed with recessed mount on the walls / ceiling.

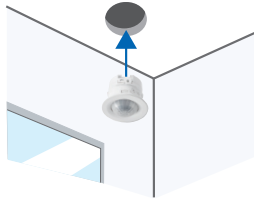

Recessed Mount with 86-type box

86-type box mount is available by using the included decorative plate.

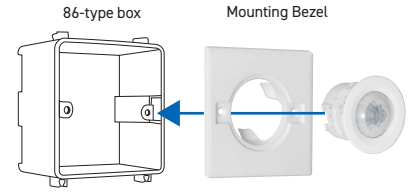

Detection areas

AP-360B/360BR

[Ceiling Mount]

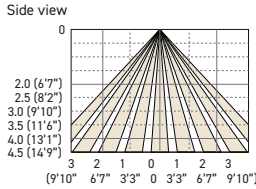
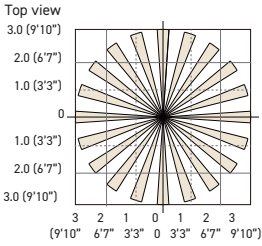

AP-20NB/20NBR

[Ceiling Mount]

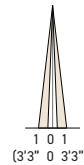
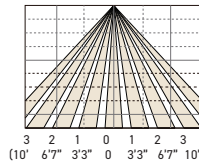

- Wall mount : Lower than 1.5 m (4.9 ft.) height (AP-20NB/20NBR only)
 - Ceiling mount : 2.5 to 4.5 m (8.2 to 14.8 ft.) height

[Wall Mount]

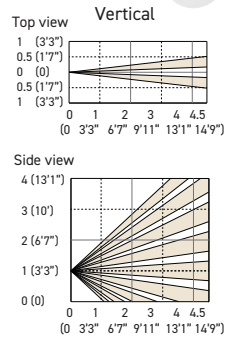
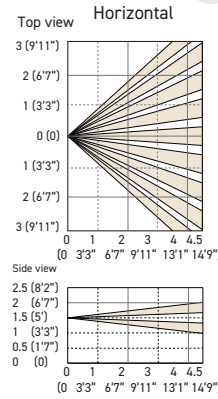

Unit: m (ft., in.)

Specifications

Model	AP-360B(C)	AP-360BR(C)	AP-20NB(C)	AP-20NBR(C)
Detection method	Passive infrared		Passive infrared	
Detection area	ø6 m (ø20') at mounting height 4.5 m (14'9")	ø6 m (ø20') at mounting height: 4.5 m (14'9" ft.)	< Ceiling mount > 6.0 m x 1.0 m (20' x 3'3") at 4.5 m (14'9") height	< Wall mount > 6.0 m x 4.5 m (20' x 14'9") at 1.5 m (4'11") height
Mounting height	2.5 to 4.5 m (8'2" to 14'9")	2.5 to 4.5 m (8'2" ft. to 14'9" ft.)	2.5 m to 4.5 m (8'2" to 14'9")	1.5 m (4'11"): Horizontal 1.0 m (3'3"): Vertical
Mounting type	Recessed ceiling mount/86-type box mount		Recessed ceiling mount/ Wall mount/ 86-type box mount	
Sensitivity	2.0°C at 0.6 m/s (3.6°F at 2'/s)		2.0°C at 0.6 m/s (3.6°F at 2'/s)	
Detection speed	0.3 to 3.0 m/s (1'/s to 9'10"/s)		0.3 to 3.0 m/s (1'/s to 9'10"/s)	
LED indicator	Warm-up upon power on: blinking Stand-by: off Alarm: solid on	Warm-up upon power on: blinking Stand-by: off Walk test: solid on Alarm: off	Warm-up upon power on: blinking Stand-by: off Alarm: solid on	Warm-up upon power on: blinking Stand-by: off Walk test: solid on Alarm: off
Alarm cycle	2 s to 120 s (variable)	Approx. 2 s	Approx. 2 s	
Illuminance	20 to 320 lux (variable/not detected)	-	-	
Battery saving timer	-	120 s / 5 s selectable	-	120 s / 5 s selectable
Alarm output	N.O./N.C., 28 V DC 200 mA max.	N.O./N.C., 3.6 V DC 10 mA max.	N.O./N.C., 28 V DC 200 mA max.	N.O./N.C., 3.6 V DC 10 mA max.
Tamper switch	N.C. 28 V DC 100 mA max. The contact opens once the casing is detached.		N.C. 28 V DC 100 mA max. The contact opens once the casing is detached.	
Warm-up time	Approx. 60 s		Approx. 60 s	
Power supply	9.5 to 16 V DC	2.7 to 3.6 V DC (CR123A battery)	9.5 to 16 V DC	2.7 to 3.6 V DC (CR123A battery)
Current	12 V DC Stand-by: 11mA, Max.: 13 mA	3 V DC Stand-by: 10µA, Max.: 4 mA	12 V DC Stand-by: 11mA, Max.: 13 mA	3 V DC Stand-by: 10µA, Max.: 4 mA
PIR sensitivity	H/ M/ L		H/ M/ L	
Weight	50 g (1.76 oz)		50 g (1.76 oz)	
Operation temperature	-20 to +50°C (-4°F to +122°F)		-20 to +50°C (-4°F to +122°F)	
Operation humidity	< 95%		< 95%	
Location	Indoors		Indoors	
Dimensions	ø52 x 42.5 mm (ø2.05 in. x 1.67 in.); without switch box mount 86 x 86 x 42.5 mm (3.39 x 3.39 x 1.67 in.); with 86-type box mount		ø52 x 35.5 mm (ø2.05 in. x 1.40 in.); without switch box mount 86 x 86 x 36.5 mm (3.39 x 3.39 x 1.44 in.); with 86-type box mount	

• Specifications and designs are subject to change without prior notice.
 • These units are designed to detect an intruder and activate an alarm control panel. Being only a part of a complete system, we cannot accept responsibility for any damages or other consequences resulting from an intrusion.

Dimensions

AP-360B/360BR

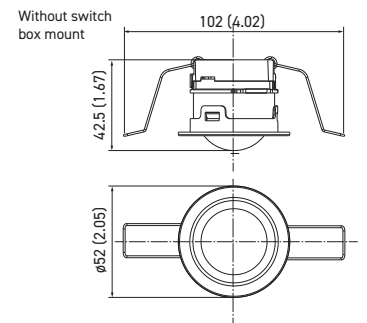

AP-20NB/20NBR

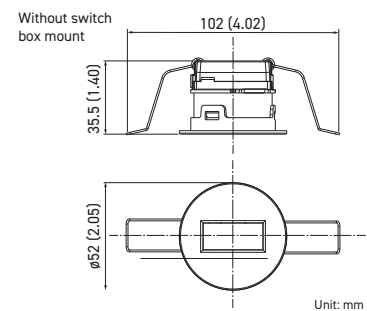

Unit: mm

Web based manual



OPTEX CO., LTD. (JAPAN)
 www.optex.co.jp/e

OPTEX INC. / AMERICAS HQ (U.S.)
 www.optexamerica.com
 OPTEX EMEA Security Headquarters
 OPTEX EUROPE LTD (UK)
 OPTEX Security B.V. (EU)
 www.optex-europe.com

OPTEX SECURITY SAS (France)
 www.optex-europe.com/fr
 OPTEX SECURITY Sp.z o.o. (Poland)
 www.optex-europe.com/pl
 OPTEX PINNACLE INDIA, PVT., LTD. (India)
 www.optexpinnacle.com
 OPTEX KOREA CO., LTD. (Korea)
 www.optexkorea.com

OPTEX (DONGGUAN) CO., LTD.
 SHANGHAI OFFICE (China)
 www.optexchina.com
 OPTEX (Thailand) CO., LTD. (Thailand)
 www.optex.co.th