

Quick Installation Guide

5GHz 9dBi 11AC 867Mbps Outdoor CPE  
O1-5G

Package contents

- CPE x 1
- PoE Injector x 1
- Power Adapter x 1
- Plastic Strap x 1
- Quick Installation Guide x 1

Please read this quick installation guide before you start. You can visit our website at [www.tendacn.com](http://www.tendacn.com) for more information about the device.

Indicators & Slots

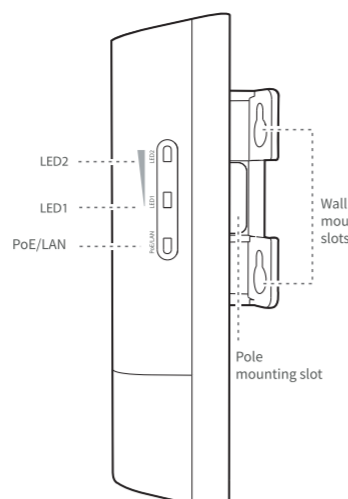

LED Indicator/Slot	Status	Description
LED1, LED2 (Signal strength indicator)	Solid on/ blinking	- Solid on: The CPE is working in AP mode, and connected to wireless clients. - Blinking: The CPE is working in Station (Client) mode, and connected to a remote AP. The LED indicator lights up when the received signal strength reaches the threshold of the corresponding LED indicator. You can check the connection status of the CPE according to the indicator status. The default threshold for each LED is shown as below.  -40 dBm -20 dBm  You can log in to the web UI of the CPE and modify the threshold on the <b>Wireless &gt; Advanced</b> page.
	Off	- For CPE in AP mode: The CPE is not connected to a wireless client, or the received signal strength does not reach the minimum threshold of the signal strength indicators (default threshold: -90 dBm). - For CPE in Station mode: The CPE is not connected to the peer AP, or the received signal strength does not reach the minimum threshold of the signal strength indicators (default threshold: -90 dBm).
PoE/LAN	Solid on	Power is supplied to the CPE properly, and no data is being transmitted.
	Blinking	Power is supplied to the CPE properly, and data is being transmitted over the port.
	Off	Power is not supplied to the CPE properly.
Wall mounting slots		These slots are used for wall mounting. Expansion bolts and screws should be self-prepared for installation. Recommended specifications: - Expansion bolt: outer diameter: 6 mm; length: 40 mm - Screw: PA3 x 20 mm, 4.5 mm x head diameter < 7 mm
Pole mounting slot		This slot is used for pole mounting. You should thread the plastic strap (included in package) through this slot to attach the CPE to a pole.

Ports & Button

Remove the cover of the CPE, and you can see the ports and button shown as below.

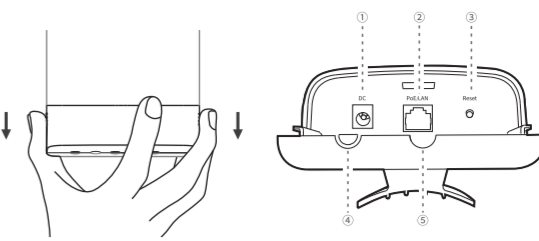

ID	Port/Button	Description
①	DC	Power jack. You can connect the included power adapter to this jack for power supply to the CPE.
②	PoE/LAN	10/100 Mbps PoE multiplex network port for power input or data transmission. - When the power socket is far away from the CPE installation location, you can use an Ethernet cable (CAT5e or better Ethernet cable is recommended) to connect this port and the PoE injector for power supply. The length of the Ethernet cable should not exceed 100 meters. - If the CPE is powered on using a power adapter, this port can be connected to a computer, switch or IP camera.
③	Reset	Reset button. When the PoE/LAN LED indicator lights solid on or blinks, hold down this button for about 8 seconds, and release it until all indicators light up and then light off. When the PoE/LAN LED indicator lights solid on or blinks again, the CPE is restored to the factory settings.
④	Power cord inlet	When using a power adapter to power the CPE, you should cut off this inlet to fix the power cord.
⑤	Ethernet cable inlet	/

Get to know the PoE injector

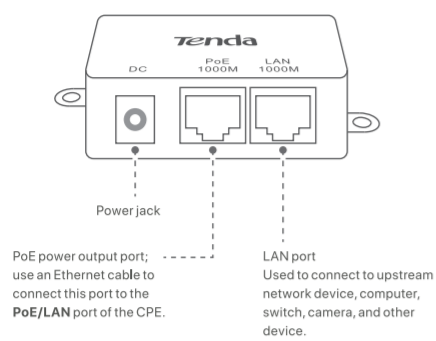

PoE power output port: use an Ethernet cable to connect this port to the PoE/LAN port of the CPE.  
LAN port: Used to connect to upstream network device, computer, switch, camera, and other device.

Power on the CPE

Option 1: Use the PoE injector

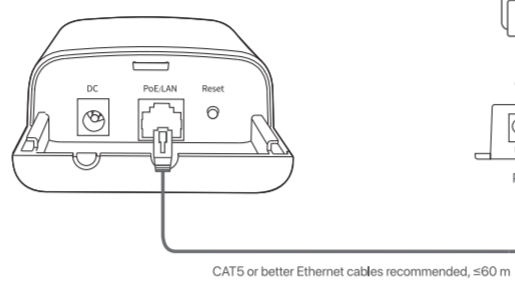

Option 2: Use the power adapter

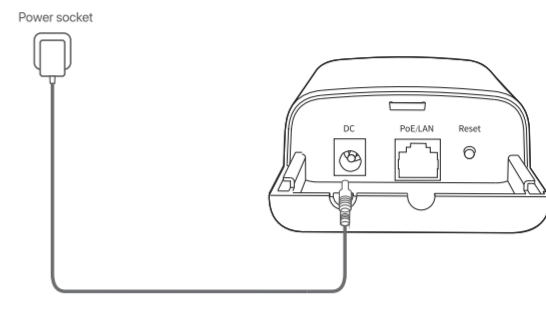

Point to Point Connection for CCTV Surveillance

1. Set up the CPEs (AP + Station Mode)

**Tips**  
At least two CPEs are required for bridging.

Method 1: Automatic Bridging (Recommended)

Peer-to-peer bridging

**Note:**  
- Automatic bridging is only applicable when the CPEs are in factory settings, and the bridging process lasts less than 1 minute after the CPEs are powered on.  
- Automatic peer-to-peer bridging could fail if three or more powered CPEs in factory settings are placed nearby.

Place two CPEs in factory settings next to each other and power them on. The LED1 and LED2 indicators of the two CPEs blink fast. When the LED1 and LED2 indicators of one CPE light solid on and those of the other CPE blink slowly, the automatic bridging succeeds. After the bridging succeeds, the DHCP server of the CPEs will be disabled automatically. The IP address of the CPE working in AP mode remains 192.168.2.1, and the IP address of the CPE working in Station mode is changed into 192.168.2.2.

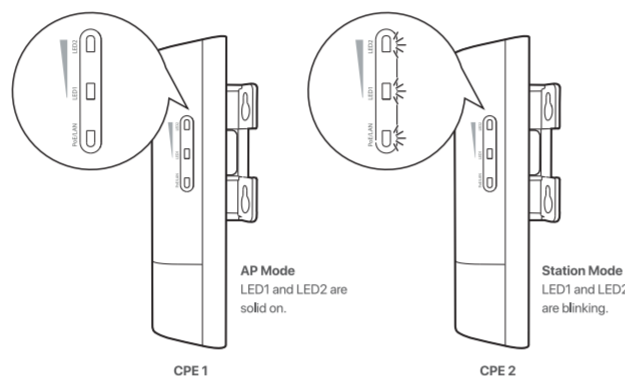

Peer-to-multiple peers bridging

**Tips**  
- The automatic peer-to-multiple peers bridging lasts for 30 minutes. During this period, the CPE working in AP mode must be kept powered on. Otherwise, other CPEs will fail to perform automatic bridging.  
- One CPE can bridge to 15 CPEs at most.

- Perform Peer-to-peer bridging to bridge any two CPEs.
- Within 30 minutes after peer-to-peer bridging succeeds, place other CPEs in factory settings near the CPE working in AP mode (LED1 and LED2 are solid on) and power them on.

When the LED1 and LED2 indicators of them are blinking slowly, the bridging of all other CPEs succeeds. After the bridging succeeds, the DHCP servers of the CPEs are disabled automatically. The IP address of the CPE in AP mode remains 192.168.2.1, and the IP address of CPEs in Station mode is changed into 192.168.2.2. If required, please visit [www.tendacn.com](http://www.tendacn.com) to download the CPE management software and install it on your computer to change the IP addresses in batch.

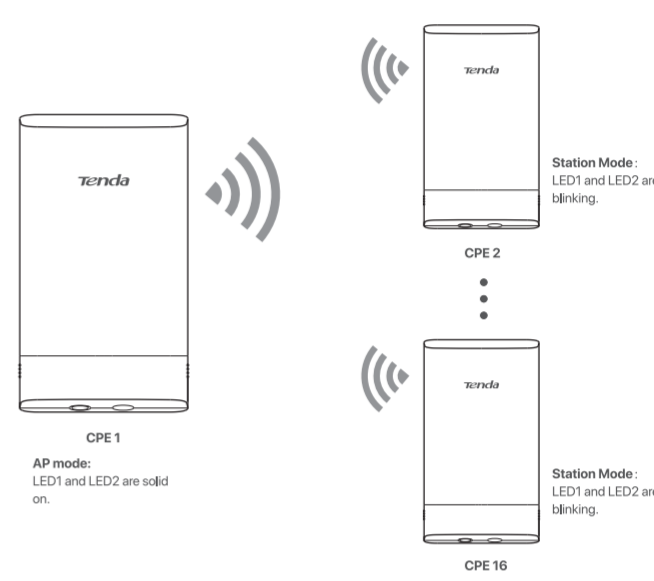

Method 2: Manual Bridging

**Step1:** Place the two CPEs next to each other.

**Step2:** Log in to the web UI of CPE1.

- Power on CPE1.
- Use an Ethernet cable to connect your computer to the PoE/LAN port of CPE1. The PoE/LAN indicator lights up.
- Start a web browser on the computer and visit 192.168.2.1. Enter the login user name and password and click Login.

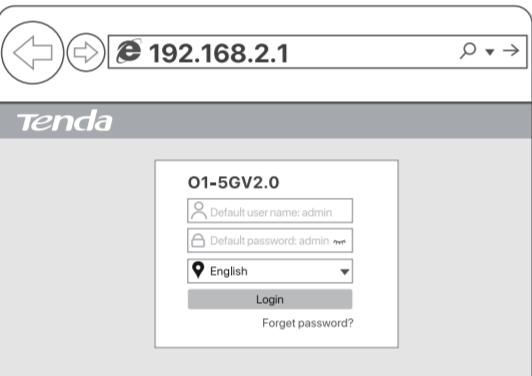

**Tips**  
If this page does not appear, please refer to Q1 in FAQ.

**Step3:** Set CPE1 to AP Mode.

● On the **Quick Setup** page, Select **AP**, and click **Next**.

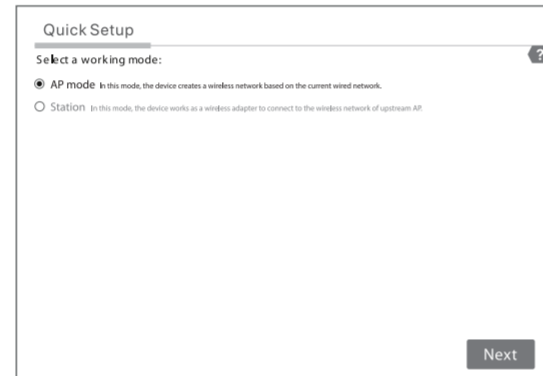

● Customize your **SSID** (WiFi name) and **Key** (WiFi password), select a **Channel**, a **Channel Bandwidth**, a **Security Mode** (WPA2-PSK is recommended) and an **Encryption Algorithm**. Click **Next**.  
Record the **SSID** and **Key** for later setup.



● Click **Save**, and wait until the CPE reboots automatically to activate the settings.

**Step4:** Set CPE2 to Station Mode.

● Perform **Step 2** to log in to the web UI of CPE2.



● On the **Quick Setup** page, select **Station** and click **Next**.

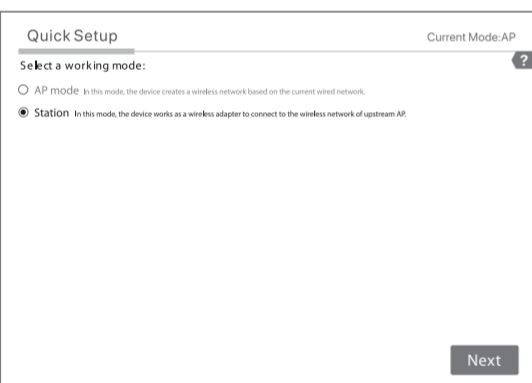

● Select the **SSID** of CPE1, which is **Tenda\_123456** in this example, and click **Next**.

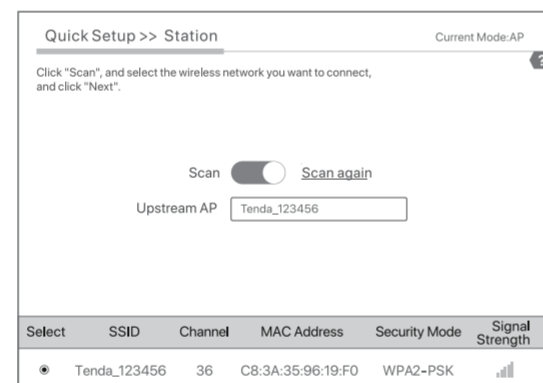

● Enter the **Key** of CPE1, and click **Next**.

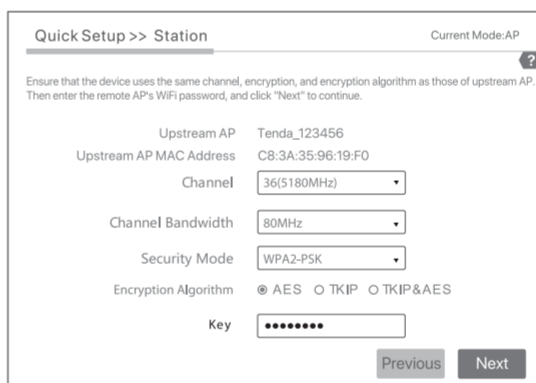

● Set the **IP** address to an unused IP address belonging to the same network segment as that of CPE1. For example, if the IP address of CPE1 is 192.168.2.1, you can set this IP address to 192.168.2.X (X ranges from 2 to 254). Then click **Next**.

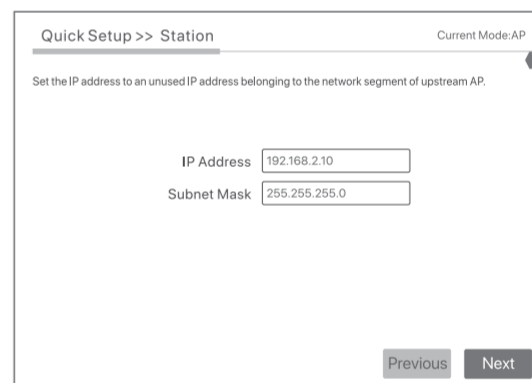

● Click **Save**, and wait until the CPE reboots to activate the settings.

When LED1 and LED2 of CPE1 are solid on, and LED1 and LED2 of CPE2 are blinking slowly, the bridging succeeds. If you want to perform peer-to-multiple peers bridging, refer to **Step 4** to bridge the new CPEs to the WiFi network of CPE1.

2. Install the CPEs

**Tips**  
The equipment is suitable for mounting at heights > 2 m.

Pole mounting is used for illustration here.

- Choose an elevated, open location for installation.
- Use the plastic straps to attach the CPEs to the selected poles. Adjust their location and direction, and tighten the straps to fix the CPEs.
- Power on CPEs.
- Connect the CPE with the LED1 and LED2 indicators solid on (AP mode – the transmitting end) to the switch which is connected to an NVR (Network Video Recorder).
- Connect the CPE with the LED1 and LED2 indicators blinking (Station mode – the receiving end) to an IP camera or a switch which is connected to IP cameras.

After successful installation, the connection quality reaches the best when the LED1 and LED2 indicators of the CPEs light solid on or blink.

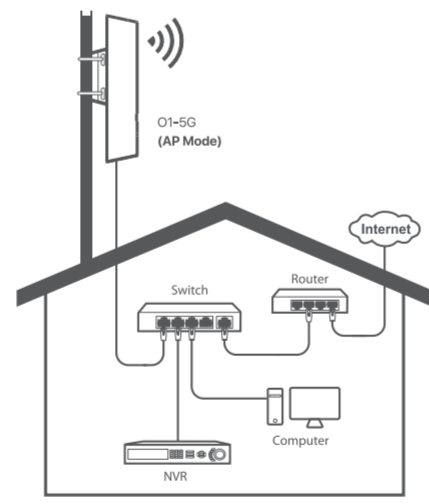

Figure 1

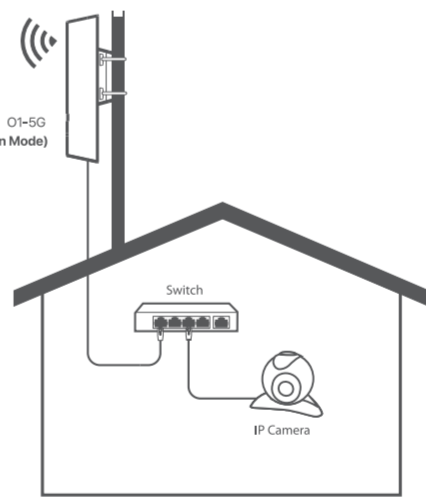

Figure 2

Safety Precautions

Before performing an operation, read the operation instructions and precautions to be taken, and follow them to prevent accidents. The warning and danger items in other documents do not cover all the safety precautions that must be followed. They are only supplementary information, and the installation and maintenance personnel need to understand the basic safety precautions to be taken.

- Do not use the device in a place where wireless devices are not allowed.
- Please use the included power adapter.
- Keep the device away from water, fire, high electric field, high magnetic field, and inflammable and explosive items.
- Do not use the power adapter if its plug or cord is damaged.
- If such phenomena as smoke, abnormal sound or smell appear when you use the device, immediately stop using it and disconnect its power supply, unplug all connected cables, and contact the after-sales service personnel.

Disassembling or modifying the device or its accessories without authorization voids the warranty, and might cause safety hazards.

FAQ

**Q1: I cannot log in to the web UI of the CPE by entering its IP address. What should I do?**

- Try the following methods:  
- Ensure that the CPE is properly connected.  
- Ensure that the IP address of the computer is in the same network segment with the CPE's IP address. For example, if the IP address of the CPE is 192.168.2.1, you can set the IP address of the computer to 192.168.2.X (X ranges from 2 to 254 and is not occupied).  
- Reset the CPE to factory settings.

**Q2: How to reset the CPE to factory settings?**

**Note:** Resetting the CPE will clear the configuration you set before, and you need to configure it again.

**Method 1:** When the PoE/LAN LED indicator lights solid on or blinks, hold down the Reset button for about 8 seconds and release it until all indicators light up and then light off. When you see the PoE/LAN LED indicator lights solid on or blinks again, the CPE is restored to factory settings.

**Method 2:** Log in to the web UI of the CPE, click **Tools > Maintenance**, and then click **Reset** button.

**Q3: How do I know whether the bridging connection quality is the best?**

**Method 1:** Check the signal strength LED indicators on the CPE. If both the LED1 and LED2 indicators light solid on or blink, the connection quality is the best.

**Method 2:** Log in to the web UI of the CPE, and check **Wireless Status** on the **Status** page.  
Stronger signal strength (-90 is better than -100) and less background noise (-100 is better than -90) lead to better bridging signal.

Wireless Status		Signal Strength	Background Noise	Transmit/Receive Rate
[Progress Bar]		- 82 dBm	- 83 dBm	52Mbps/Mbps

The CPE is used outdoors. The power adapter is used indoors.

**Q4: The automatic bridging fails. What should I do?**

Try the following methods:

- Peer-to-peer bridging: If the peer-to-peer bridging fails, restore the two CPEs to factory settings, and try again.
- Peer-to-multiple peers bridging:  
- For the CPEs that fail to bridge within 30 minutes after peer-to-peer bridging succeeds, reset them and try again.  
- For the CPEs that fail to bridge beyond 30 minutes after peer-to-peer bridging succeeds, set the rest CPEs to Station mode using web UI, and then connect them to the wireless network of the CPE whose LED1 and LED2 are solid on.

**Q5: After successful bridging, there is no display of the scenes monitored at the NVR side. What should I do?**

- Try the following methods:  
- Ensure that all devices are powered on properly and Ethernet cables are connected properly.  
- Ensure that the computer, NVR and IP camera are in the same network segment, and the NVR configuration and IP camera configuration are correct.  
- If the IP camera can be scanned but cannot be added at the NVR side, ensure that the **Transparent Bridge** function is enabled and the IP camera is already in initialization (active) state.  
- If the IP camera cannot be scanned at the NVR side, please refer to the following procedure to solve this issue.

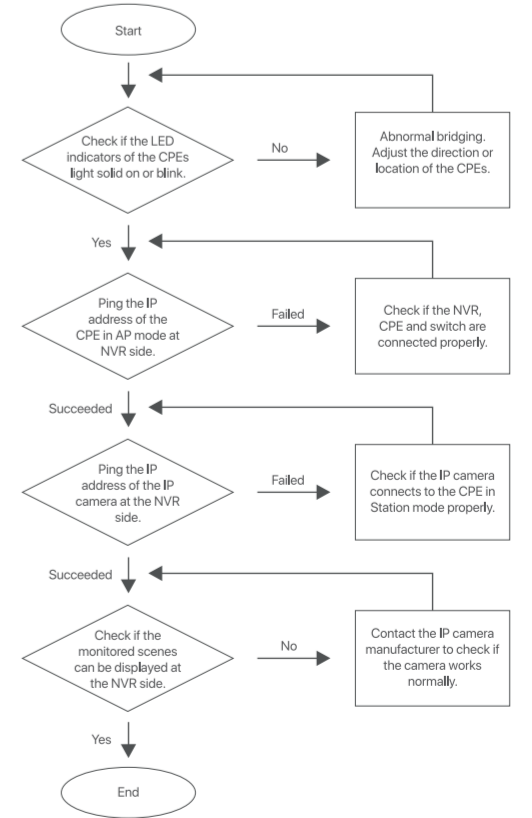

CE

**CE Mark Warning**  
This is a Class A product. In a domestic environment, this product may cause radio interference, in which case the user may be required to take adequate measures.  
This equipment should be installed and operated with a minimum distance of 20 cm between the device and your body.  
The mains plug is used as a disconnect device, the disconnect device shall remain readily operable.

**NOTE:** (1) The manufacturer is not responsible for any radio or TV interference caused by unauthorized modifications to this equipment. (2) To avoid unnecessary radiation interference, it is recommended to use a shielded RJ45 cable.

**Declaration of Conformity**  
Herby, SHENZHEN TENDA TECHNOLOGY CO., LTD. declares that the radio equipment type O1-5G is in compliance with Directive 2014/53/EU. The full text of the EU declaration of conformity is available at the following internet address: <https://www.tendacn.com/download/list-9.html>

Operating Frequency Range: EU/5150-5250MHz (CH36-CH48)  
ERP Power (Max.): 22.36dBm  
EU/5470-5725MHz (CH100-CH116, CH132-CH140)  
ERP Power (Max.): 26.98dBm  
Software Version: V1.0.0.10

**Caution:**  
Adapter Model: BN073-A12012B, BN073-A12012E  
Manufacturer: SHENZHEN HEWESHIJUN NETWORK TECHNOLOGY CO., LTD.  
Input: 100 - 240V AC, 50/60Hz 0.4A  
Output: 12V DC, 1A  
DC Voltage  
The CPE is used outdoors. The power adapter is used indoors.

**RECYCLING**  
This product bears the selective sorting symbol for Waste electrical and electronic equipment (WEEE). This means that this product must be handled pursuant to European directive 2012/19/EU in order to be recycled or dismantled to minimize its impact on the environment. User has the choice to give his product to a competent recycling organization or to the retailer when he buys a new electrical or electronic equipment.

Operating Temperature: -30°C - 55°C  
Operating Humidity: (10% - 90%) RH, non-condensing

For EU/EFTA, this product can be used in the following countries:

BE	BG	CZ	DK	DE	EE	EL	ES	FR	HR	IT	CY	LV
LT	LU	HU	MT	NL	AT	PL	PT	RO	SI	SK	FI	SE



FCC

**FCC Statement**  
This equipment has been tested and found to comply with the limits for a Class A digital device, pursuant to Part 15 of the FCC Rules. These limits are designed to provide reasonable protection against harmful interference when the equipment is operated in a commercial environment. This equipment generates, uses, and can radiate radio frequency energy and, if not installed and used in accordance with the instruction manual, may cause harmful interference to radio communications. Operation of this equipment in a residential area is likely to cause harmful interference in which case the user will be required to correct the interference at his own expense.

Operation is subject to the following two conditions: (1) this device may not cause harmful interference, and (2) this device must accept any interference received, including interference that may cause undesired operation.

**Radiation Exposure Statement**  
This device complies with FCC radiation exposure limits set forth for an uncontrolled environment and it also complies with Part 15 of the FCC RF Rules. This equipment should be installed and operated with a minimum distance of 20 cm between the device and your body.

**Caution!**  
Any changes or modifications not expressly approved by the party responsible for compliance could void the user's authority to operate the equipment.

This transmitter must not be co-located or operating in conjunction with any other antenna or transmitter.  
Operating frequency: 5150-5250MHz; 5725-5850MHz

**NOTE:** (1) The manufacturer is not responsible for any radio or TV interference caused by unauthorized modifications to this equipment. (2) To avoid unnecessary radiation interference, it is recommended to use a shielded RJ45 cable.

**Technical Support**  
Shenzhen Tenda Technology Co., Ltd.  
Floor 6-8, Tower E3, No.1001, Zhongshanyuan Road, Nanshan District, Shenzhen, China, 518052  
USA hotline: 1-800-570-5892  
Toll Free: Daily-9am to 6pm PST  
Canada hotline: 1-888-998-8966  
Toll Free: Mon-Fri 9 am - 6 pm PST  
Hong Kong hotline: 00852-81931998  
Global hotline: +86 755-2785 7180 (China Time Zone)  
Website: [www.tendacn.com](http://www.tendacn.com)  
E-mail: [support@tenda.com.cn](mailto:support@tenda.com.cn)

**Copyright**  
© 2022 Shenzhen Tenda Technology Co., Ltd. All rights reserved.  
Tenda is a registered trademark legally held by Shenzhen Tenda Technology Co., Ltd. Other brand and product names mentioned herein are trademarks or registered trademarks of their respective holders. Specifications are subject to change without notice.  
V1.0. For future reference.