

Ruijie Reyee RG-RAP2260 Access Point

Installation Guide

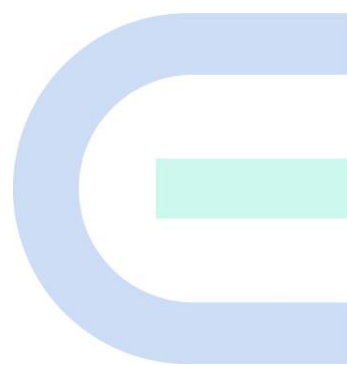

Copyright

Ruijie Networks©2024

All rights are reserved in this document and this statement.

Without the prior written consent of Ruijie Networks, any organization or individual shall not reproduce, extract, back up, modify, or propagate the content of this document in any manner or in any form, or translate it into other languages or use some or all parts of the document for commercial purposes.



and other Ruijie networks logos are trademarks of Ruijie Networks.

All other trademarks or registered trademarks mentioned in this document are owned by their respective owners.

Disclaimer

The products, services, or features you purchase are subject to commercial contracts and terms, and some or all of the products, services, or features described in this document may not be available for you to purchase or use. Except for the agreement in the contract, Ruijie Networks makes no explicit or implicit statements or warranties with respect to the content of this document.

The names, links, descriptions, screenshots, and any other information regarding third-party software mentioned in this document are provided for your reference only. Ruijie Networks does not explicitly or implicitly endorse or recommend the use of any third-party software and does not make any assurances or guarantees concerning the applicability, security, or legality of such software. You should choose and use third-party software based on your business requirements and obtain proper authorization. Ruijie Networks assumes no liability for any risks or damages arising from your use of third-party software.

The content of this document will be updated from time to time due to product version upgrades or other reasons, Ruijie Networks reserves the right to modify the content of the document without any notice or prompt.

This manual is designed merely as a user guide. Ruijie Networks has tried its best to ensure the accuracy and reliability of the content when compiling this manual, but it does not guarantee that the content of the manual is completely free of errors or omissions, and all the information in this manual does not constitute any explicit or implicit warranties.

Preface

Intended Audience

This document is intended for:

- Network engineers
- Technical support and servicing engineers
- Network administrators

Technical Support

- Official Website of Ruijie Reyee: <https://reyee.ruijie.com>
- Technical Support Website: <https://reyee.ruijie.com/en-global/support>
- Case Portal: <https://www.ruijienetworks.com/support/caseportal>
- Community: <https://community.ruijienetworks.com>
- Technical Support Email: service_rj@ruijienetworks.com
- Online Robot/Live Chat: <https://reyee.ruijie.com/en-global/rita>

Conventions

1. Signs

The signs used in this document are described as below:

Danger

An alert that calls attention to safety operation instructions that if not understood or followed when operating the device can result in physical injury.

Warning

An alert that calls attention to important rules and information that if not understood or followed can result in data loss or equipment damage.

Caution

An alert that calls attention to essential information that if not understood or followed can result in function failure or performance degradation.

Note

An alert that contains additional or supplementary information that if not understood or followed will not lead to serious consequences.

Specification

An alert that contains a description of product or version support.

2. Note

This manual provides the device installation steps, hardware troubleshooting, module technical specifications, and specifications and usage guidelines for cables and connectors. It is intended for the users who have some experience in installing and maintaining network hardware. At the same time, it is assumed that the users are already familiar with the related terms and concepts.

Contents

Preface	1
1 Product Overview.....	1
1.1 Product Appearance	1
1.1.1 Front Panel of the AP	1
1.1.2 Rear Panel of the AP	2
1.2 Technical Specifications	2
1.3 Power Supply.....	4
1.4 Cooling Solution	4
2 Preparing for Installation	5
2.1 Safety Precautions.....	5
2.2 Installation Precautions	5
2.3 Handling Safety	5
2.4 Electric Safety.....	5
2.5 Installation Environment Requirements	6
2.5.1 Installation Requirements	6
2.5.2 Ventilation Requirements	6
2.5.3 Temperature/ Humidity Requirements	6
2.5.4 Cleanliness Requirements.....	6
2.5.5 Power Supply Requirements.....	7
2.5.6 EMI Requirements	7
2.6 Tools.....	8
2.7 Unpacking the Access Point.....	8
3 Installing the Access Point.....	9
3.1 Installation Procedure.....	9
3.2 Before You Begin	9
3.3 Precautions	9
3.4 Installing the Access Point	10
3.5 Removing the Access Point.....	11
3.6 Connecting Cables.....	12
3.7 Bundling Cables	12
3.8 Checking after Installation	12
4 Verifying Operating Status.....	13
4.1 Setting up a Configuration Environment.....	13
4.2 Checklist.....	13
4.2.1 Checklist before Power-on.....	13
4.2.2 Checklist after Power-on (Recommended)	13
5 Monitoring and Maintenance	14
5.1 Monitoring.....	14
5.2 Hardware Maintenance	14
6 Troubleshooting.....	15
6.1 General Troubleshooting Procedure	15
6.2 Common Troubleshooting Procedures	15
6.2.1 The LED does not light up after the AP is powered on.....	15
6.2.2 The Ethernet port is not working after the Ethernet port is connected.....	15
6.2.3 The wireless client cannot discover the AP.....	15
7 Appendix.....	17
7.1 Appendix A Connectors and Media	17
7.2 Appendix B Cabling Recommendations	19
7.2.1 Requirements for Minimum Cable Bend Radius	19
7.2.2 Precautions for Cable Bundling	19

1 Product Overview

The RG-RAP2260 is a dual-radio ceiling-mounted wireless access point (AP) with one 2.5GE port, delivering an access rate of up to 3000 Mbps per device. The AP is designed by Ruijie Networks for indoor Wi-Fi coverage scenarios within medium- and large-sized areas. RG-RAP2260 adopts either 802.3at standard PoE power supply or local 12 V DC adapter power supply. Compliant with IEEE 802.11a/b/g/n/ac/ax, the device can simultaneously work in the 2.4 GHz and 5 GHz bands. RG-RAP2260 also supports dual-stream MU-MIMO and provides an access rate of up to 574 Mbps at 2.4 GHz and 2402 Mbps at 5 GHz with a high throughput of up to 2976 Mbps per device. The AP provides one 2.5GE port and one GE port, making it possible to connect a camera or an Ethernet switch for varied service networking needs.

1.1 Product Appearance

1.1.1 Front Panel of the AP

Figure 1-1 Front Panel of RG-RAP2260



Table 1-1 Front Panel Specification

Item	Status	Description
LED	Solid blue	The AP is operating normally. No alarm occurs.
	Off	The AP is not receiving power.
	Fast flashing	The AP is starting up.
	Slow flashing (at 0.5 Hz)	The network is unreachable.
	Flashing twice in succession	<ol style="list-style-type: none"> The AP is restoring the factory settings. The AP is upgrading the software. <p>⚠ Do not power off the device in this case.</p>
	One long flash followed by three short flashes.	Other faults occur.

1.1.2 Rear Panel of the AP

Figure 1-2 Rear Panel of RG-RAP2260

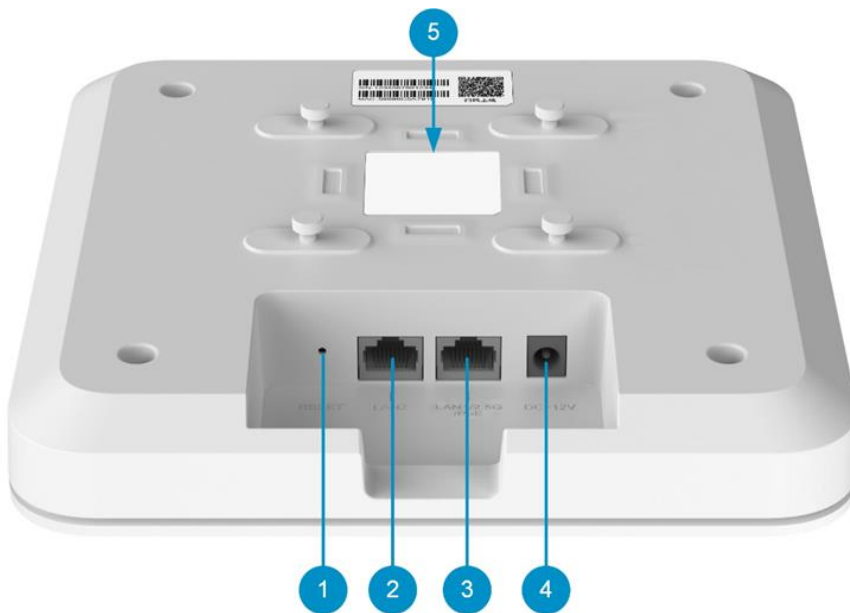

Table 1-2 Rear Panel Specifications

No.	Item	Description
1	Reset Button	Press for less than 2s: The device is restarting.
		Press the Reset button for 2s to 5s: The device does not respond.
		Press for more than 5s: The device restores the factory settings.
2	LAN2	One 10/100/1000M Base-T Ethernet port
3	LAN1/PoE	One 10/100/1000/2500M Base-T PoE-capable Ethernet port
4	DC Input Plug	DC power plug
5	Label	The label is located on the bottom of the device.

1.2 Technical Specifications

Table 1-3 Technical Specifications of an RG-RAP2260 Access Point



RF Design	Dual-stream and dual-radio
Transmission Protocol	Compliant with 802.11ax, 802.11ac wave2/wave1 and 802.11a/b/g/n.
Operating Bands	802.11b/g/n/ax: 2.4 GHz to 2.4835 GHz 802.11a/n/ac/ax: 5.150 GHz to 5.350 GHz, 5.470 GHz to 5.725 GHz , 5.725 GHz to

	5.850 GHz
Antenna Type	2.4 GHz, two spatial streams, 2 x 2 MIMO 5 GHz, two spatial streams, 2 x 2 MIMO
Max Throughput	2.4 GHz: up to 574 Mbps 5 GHz: up to 2402 Mbps Up to 2.976 Gbps per AP
Modulation	OFDM: BPSK@6/9 Mbps, QPSK@12/18 Mbps, 16QAM@24 Mbps, 64QAM@48/54 Mbps DSSS: DBPSK@1 Mbps, DQPSK@2 Mbps, CCK@5.5/11 Mbps MIMO-OFDM: BPSK, QPSK, 16QAM, 64QAM, 256QAM, 1024QAM OFDMA
Receive Sensitivity	11b: -91 dBm (1 Mbps), -90 dBm (5.5 Mbps), -87 dBm (11 Mbps) 11a/g: -89 dBm (6 Mbps), -82 dBm (24 Mbps), -78 dBm (36 Mbps), -72 dBm (54 Mbps) 11n: -85 dBm (MCS0), -67dBm (MCS7), -62 dBm (MCS8) 11ac: 20 MHz: -85 dBm (MCS0), -62 dBm (MCS8) 11ac: 40 MHz: -82 dBm (MCS0), -59 dBm (MCS8) 11ac: 80 MHz: -79 dBm (MCS0), -53 dBm (MCS9) 11ac: 160 MHz: -76 dBm (MCS0), -50 dBm (MCS9) 11ax: 20 MHz: -85 dBm (MCS0), -62 dBm (MCS8), -58 dBm (MCS11) 11ax: 40 MHz: -82 dBm (MCS0), -59 dBm (MCS8), -54 dBm (MCS11) 11ax: 80 MHz: -79 dBm(MCS0), -53 dBm(MCS9), -52 dBm(MCS11) 11ax: 160 MHz: -76 dBm(MCS0), -49 dBm(MCS11)
Transmit Power	EIRP: ≤ 31 dBm (2.4 GHz) ≤ 32.7 dBm (5 GHz) country-specific restrictions apply Myanmar: 2400 MHz to 2483.5 MHz: ≤ 20 dBm 5150 MHz to 5350 MHz: ≤ 23 dBm 5470 MHz to 5850 MHz ≤ 25 dBm Thailand: 2400 MHz to 2483.5 MHz: ≤ 20 dBm 5150 MHz to 5350 MHz: ≤ 23 dBm 5470 MHz to 5725 MHz: ≤ 25 dBm 5725 MHz to 5850 MHz: ≤ 30 dBm
Transmit Power Adjustment	1 dBm

Dimensions (W x D x H)	194mm x 194mm x 45.1mm (7.64 in. x 7.64 in. x 1.78 in., excluding brackets)
Weight	≤ 0.65 kg (1.43 lbs, excluding brackets)
Service Ports	One 10/100/1000/2500M Base-T PoE-capable Ethernet port One 10/100/1000M Base-T Ethernet Port
Management Ports	N/A
LED	One LED (blue)
Power Supply	Adapter: DC 12 V/2 A  The power adapter is an optional accessory with the inner diameter of 2.1 mm (0.08 in.), the outer diameter of 5.5 mm (0.22 in.) and the depth of 10 mm (0.39 in.). PoE: IEEE 802.3at-compliant
Max Power Consumption	18 W
Temperature	Operating temperature: 0°C to 40°C (32°F to 104°F) Storage temperature: -40°C to 70°C (-40°F to 158°F)
Humidity	Operating humidity: 5% to 95% RH (non-condensing) Storage humidity: 5% to 95% RH (non-condensing)
Certification	CE
MTBF	> 400,000H

1.3 Power Supply

The RG-RAP2260 AP can be powered either with a power adapter or through Power over Ethernet (PoE).

-  Use DC power adapters with specifications recommended by Ruijie. The power adapter is customer-supplied.
-  If the AP adopts PoE power supply, connect the LAN1/2.5G/PoE port on the AP to the PoE-capable port on a switch or a PoE device with an Ethernet cable. Make sure that the device connected is compliant with IEEE 802.3at.



1.4 Cooling Solution

The AP adopts a fanless design.

-  Maintain a proper clearance around the AP for air circulation and normal heat dissipation.

2 Preparing for Installation

2.1 Safety Precautions

-
-  To avoid device damage and physical injury, please read the safety precautions carefully before installing the device.
 -  The following safety precautions may not cover all possible dangers.
-

2.2 Installation Precautions

- Do not expose the AP to high temperature, dust, or harmful gases.
 - Do not install the AP in an area prone to fire or explosions.
 - Keep the AP away from EMI sources such as large radar stations, radio stations, and substations.
 - Do not subject the AP to unstable voltage, vibration, and noises.
 - Keep the AP at least 500 meters away from the ocean and do not face it towards the sea breeze.
 - The installation site should be free from water including possible flooding, seepage, dripping, or condensation.
 - The installation site should be selected according to network planning and communications equipment features, and considerations such as climate, hydrology, geology, earthquake, electrical power, and transportation.
-

 Please follow the correct method described in the installation guide to install and remove the device.

2.3 Handling Safety

- Avoid frequently moving the device.
- Turn off all power supplies and unplug all power cables before you move or handle the device.

2.4 Electric Safety

- Please observe local rules and regulations when performing electric operations. Only personnel with relevant qualifications can perform such operations.
 - Carefully check for any potential hazards in the working area such as damp/wet ground or floors.
 - Learn about the location of the emergency power supply switch in the room before installation. Cut off the power supply first in case of an accident.
 - Be sure to make a careful check before shutting down the power supply.
 - Do not place the device in a damp/wet location. Do not let any liquid enter the chassis.
 - Keep the AP far away from grounding or lightning protection devices for power equipment.
 - Keep the AP away from radio stations, radar stations, high-frequency high-current devices, and microwave ovens.
-

 Any nonstandard and inaccurate electrical operation can cause an accident such as fire or electric shock, thus causing

severe even fatal damages to humans and devices.

- ❗ Direct or indirect contact with a wet object (or your finger) on the high voltage and power line can be fatal.

2.5 Installation Environment Requirements

The device must be installed indoors. To ensure its normal operation and prolonged service life, the installation site must meet the following requirements.

2.5.1 Installation Requirements

- Install the AP in a well-ventilated environment. If it is installed in a closed room, make sure there is a good cooling system.
- Make sure the site is sturdy enough to support the AP and its accessories.
- Make sure the site has enough space for installing the AP and maintain a proper clearance around the AP for ventilation.

2.5.2 Ventilation Requirements

Maintain a proper clearance around the device for air circulation and normal heat dissipation.

2.5.3 Temperature/ Humidity Requirements

To ensure the normal operation and equipment service life, maintain appropriate temperature and humidity in the equipment room. Improper room temperature and humidity can cause damage to the device.

- High relative humidity may affect insulation materials, resulting in poor insulation and even electrical leakage. Sometimes it may lead to changes in the mechanical properties of materials and corrosion of metal parts.
- Low relative humidity can dry and shrink insulation sheets and cause static electricity that can damage the circuitry.
- High temperatures greatly reduce device reliability and shorten service life.

2.5.4 Cleanliness Requirements

Dust poses a major threat to the AP. The indoor dust takes on a positive or negative static electric charge when falling on the AP, causing poor contact of the metallic joint. Such electrostatic adhesion may occur more easily when the relative humidity is low, not only affecting the service life of the AP, but also causing communication faults. The following table describes the requirements for the dust content and granularity in the equipment room.

Table 2-1 Requirements for Dust

Dust	Unit	Content
Dust particles (diameter $\geq 0.5 \mu\text{m}$)	Particles/ m^3	1.4×10^7
Dust particles (diameter $\geq 1 \mu\text{m}$)	Particles/ m^3	7×10^5
Dust particles (diameter $\geq 3 \mu\text{m}$)	Particles/ m^3	2.4×10^5

Dust particles (diameter $\geq 5 \mu\text{m}$)	Particles/m ³	1.3 $\times 10^5$
---	--------------------------	-------------------

Apart from dust, the salt, acid, and sulfide in the air in the equipment room must meet strict requirements. These harmful substances will accelerate metal corrosion and component aging. Therefore, the equipment room should be properly protected against the intrusion of harmful gases, such as sulfur dioxide, hydrogen sulfide, nitrogen dioxide, ammonia and chlorine gas. The following table lists limit values for harmful gases.

Table 2-2 Requirements for Gases

Gas	Average (mg/m ³)	Maximum (mg/m ³)
Sulfur dioxide (SO ₂)	0.2	1.5
Hydrogen sulfide (H ₂ S)	0.006	0.03
Nitrogen dioxide (NO ₂)	0.04	0.15
Ammonia (NH ₃)	0.05	0.15
Chlorine gas (Cl ₂)	0.01	0.3



i **Average** refers to the average value of harmful gases measured in one week. **Maximum** refers to the upper limit of harmful gases measured in one week, and the maximum value lasts up to 30 minutes every day.

2.5.5 Power Supply Requirements

The input voltage of the DC power adapter is 12 V and the rated current is 2 A. See the technical specifications of the DC connector in the following table.

Inner Diameter	Outer Diameter	Insertion Depth	Conductor Impedance	Voltage-endurance Impedance	Voltage-endurance (Insulator and Conductor)	Polarity
2.10 \pm 0.05 mm (0.08 \pm 0.002 in.)	5.50 \pm 0.05 mm (0.22 \pm 0.002 in.)	10 mm (0.39 in.)	5 Ω	100 M Ω	1000 V	Inner pole: positive Outer pole: negative

PoE+ injector: Compliant with IEEE 802.3at

-  The DC input power should be greater than the power actually consumed by the system.
-  Use DC power adapters with specifications recommended by Ruijie.
-  Please use Ruijie certified PoE injectors.

2.5.6 EMI Requirements

- Keep the AP far away from grounding or lightning protection devices for power equipment.

- Keep the AP away from radio stations, radar stations, high-frequency high-current devices, and microwave ovens.

2.6 Tools

Common Tools	Phillips screwdrivers, power cords, Ethernet cables, fastening bolts, diagonal pliers, and binding straps
Special Tools	Wire stripper, crimping pliers, crystal connector crimping pliers, and wire cutter
Meter	Multimeter, bit error rate tester (BERT)

 The device is delivered without a tool kit. The tools listed above are customer-supplied.

2.7 Unpacking the Access Point

Table 2-3 Package Contents

Items	<p>Verify that all parts are installed and debugged.</p> <p>Mounting brackets</p> <p>Wall anchor</p> <p>Phillips pan head screws</p> <p>A piece of label paper on which QR codes of the user manual and the App, and the certificate of qualification are printed.</p>
--------------	--

 The above listed items are for general situations, and contents may vary in the actual shipment. The purchase order shall prevail in any case. Please check each item carefully according to the package contents or purchase order. If any item is damaged or missing, please contact your sales representative.

3 Installing the Access Point

The RG-RAP2260 series must be fixed and installed indoors.



Before installing the AP, make sure you have carefully read the requirements described in Chapter 2.

3.1 Installation Procedure

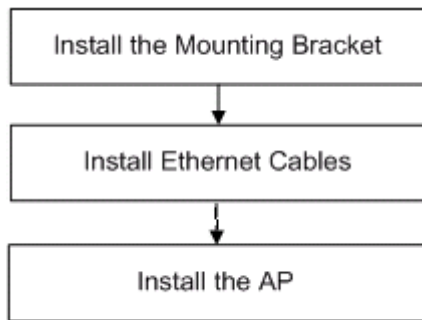

3.2 Before You Begin

Carefully plan and arrange the installation position, networking mode, power supply and cabling before installation. Confirm the following requirements before installation:

- The installation site provides sufficient space for heat dissipation.
- The installation site meets the temperature and humidity requirements of the device.
- The power supply and required current are available in the installation site.
- The selected power supply modules meet the system power requirements.
- The Ethernet cables have been deployed in the installation site.
- The installation site meets all described requirements.
- The custom AP meets the requirements of the customer.

3.3 Precautions

To ensure the normal operation and prolonged service life of the device, please observe the following precautions:

- Do not power on the device during installation.
- Install the device in a well-ventilated location.
- Do not subject the device to high temperatures.
- Keep away from high voltage cables.
- Install the device indoors.
- Do not expose the device in a thunderstorm or strong electric field.
- Keep the device clean and dust-free.

- Cut off the power switch before cleaning the device.
- Do not wipe the device with a damp cloth.
- Do not wash the device with liquid.
- Do not open the enclosure when the AP is working.
- Fasten the device tightly.

3.4 Installing the Access Point

- ⚠ You are advised to install the device where you can get the optimal signal coverage.
- ⚠ In the indoor area, the signal coverage of the ceiling-mounted device is larger than that of the wall-mounted device. Please choose the ceiling-mounted method first.

i The following are the installation diagrams for reference.

1. Take out the mounting bracket from the package and secure the bracket on the ceiling or wall with screws. The center-to-center distance between the two holes is 53 mm (2.09 in.).

Figure 3-1 Securing the Mounting Bracket on the Ceiling/Wall

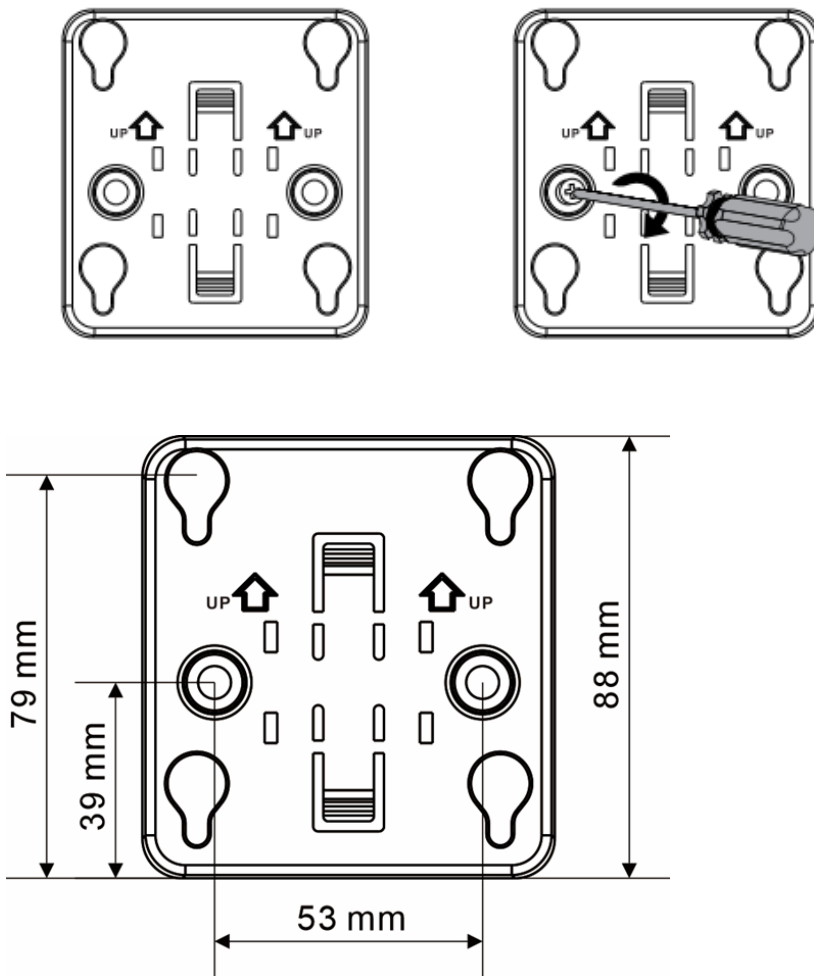

2. Connect the Ethernet cable to the LAN port on the rear panel of the AP (The LAN1/2.5G/PoE port is PoE-capable).

Figure 3-2 Connecting the Ethernet Cable to the LAN Port

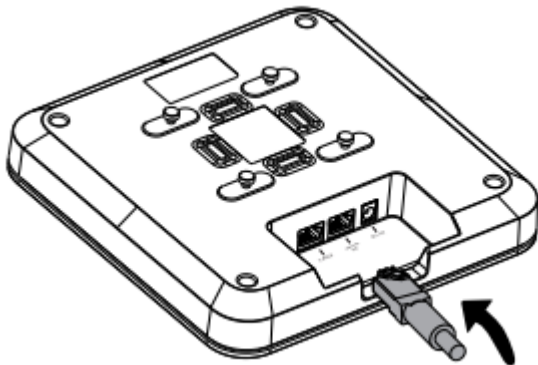

3. Align the square feet on the rear of the AP to the mounting holes on the bracket. Slide the AP into the holes until it clicks into place.

Figure 3-3 Securing the AP

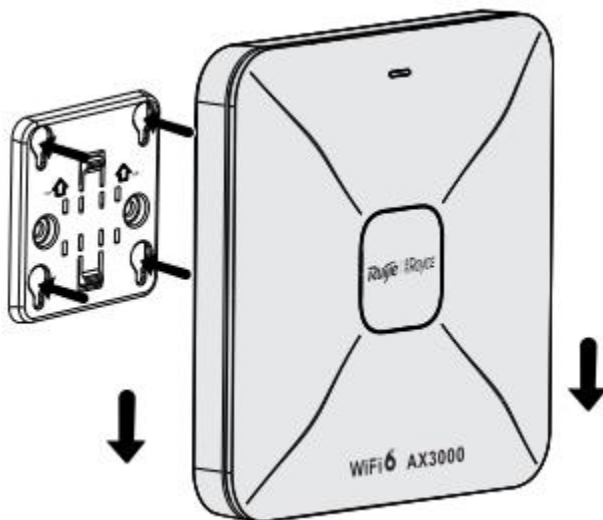

-
- ⚠ Install the Ethernet cables before securing the AP on the bracket.
 - ⚠ The AP can be installed in any of four directions on the mounting bracket depending on how you route the Ethernet cable.
 - ⚠ The square feet should fit easily into the mounting slots. Do not forcibly push the AP into the slots.
 - ⚠ After installation, verify that the AP is securely fastened.
-

3.5 Removing the Access Point

Hold the AP with your hands and push it upward and away from the bracket in the arrow direction, as shown in Figure 3-1.

3.6 Connecting Cables

Connect the UTP/STP to the LAN port on the AP (the LAN1/2.5G/PoE port is PoE-capable). See Appendix A for the supported wiring for twisted pairs.



Avoid bending the cable in a small radius close to the connector.



You are not advised to use Ethernet cables with protective sleeves as they could make the installation of Ethernet cables more difficult.

3.7 Bundling Cables



The power cords and other cables should be bundled in a visually pleasing way.



When you bundle twisted pairs, make sure that the twisted pairs at the connectors have natural bends or bends of large radius.



Do not bundle twisted pairs too tightly, as this may press hard the pairs and affect their service life and transmission performance.

Bundling Steps

- (1) Bundle the dropping part of the twisted pairs and route them to the LAN1/2.5G/PoE port for convenience.
- (2) Fasten the twisted pairs to the cable management ring or bracket. Attach the cables in the cable tray of the rack.
- (3) Bundle the twisted pairs closely along the bottom of the device and in a straight line wherever possible.

3.8 Checking after Installation

Checking Cable Connection

- Make sure the UTP/STP cable matches with the interface type.
- Make sure cables are properly bundled.

Checking the Power Supply

- Make sure the power cord is properly connected and compliant with safety requirements.
- Make sure the AP is functioning properly after it is powered on.

4 Verifying Operating Status

4.1 Setting up a Configuration Environment

Use a power adapter or PoE to power on the AP.

- Verify that the power supply is properly connected to the AP and compliant with safety requirements.
- Connect the AP to a wireless controller through a twisted pair cable.
- When the AP is connected to a PC for debugging, verify that the PC and PoE switch are properly grounded.

4.2 Checklist

4.2.1 Checklist before Power-on

- Verify that the power supply is properly connected.
- Verify that the input voltage matches with the specification of the AP.

4.2.2 Checklist after Power-on (Recommended)

After power-on, check the following to ensure normal operation of the AP.

- Check if any message is displayed on the Web-based configuration interface for the wireless controller.
- Check if the LED works normally.

5 Monitoring and Maintenance

5.1 Monitoring

When RG-RAP2260 is operating, you can monitor its status by observing the LED.

5.2 Hardware Maintenance

If the hardware is faulty, please contact the technical support personnel of Ruijie Networks.

6 Troubleshooting

6.1 General Troubleshooting Procedure

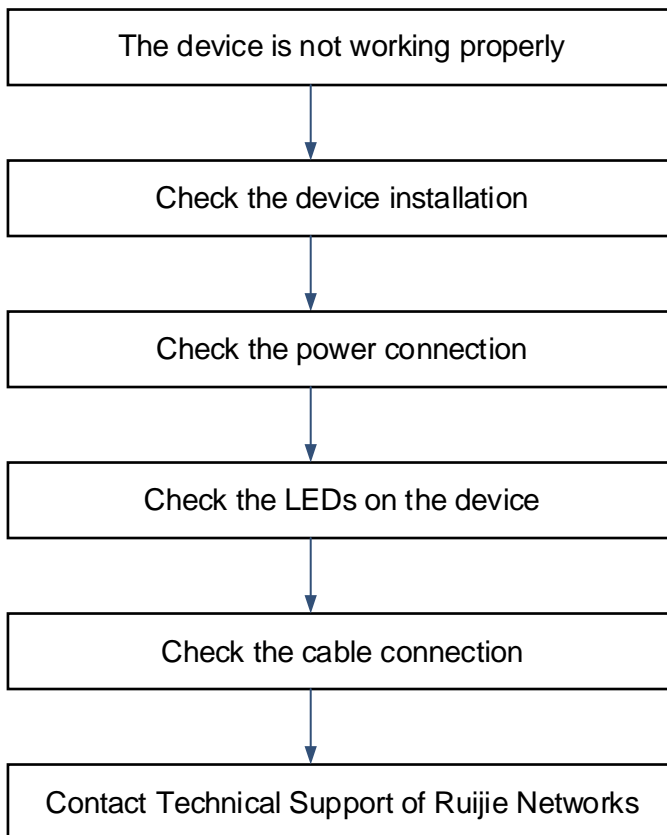

6.2 Common Troubleshooting Procedures

6.2.1 The LED does not light up after the AP is powered on

- If you use PoE power supply, verify that the power source is compliant with IEEE 802.11at; then verify that the cable is properly connected.
- If you use a power adapter, verify that the power adapter is connected to an active power outlet; then verify that the power adapter works properly.

6.2.2 The Ethernet port is not working after the Ethernet port is connected

Verify that the device at the other end of the Ethernet cable is working properly. And then verify that the Ethernet cable can provide the required data rate and is properly connected.

6.2.3 The wireless client cannot discover the AP

- (1) Verify that the power supply is functioning properly.

- (2) Verify that the cables are properly connected.
- (3) Verify that the AP is correctly configured.
- (4) Move the client to adjust the distance between the client and the AP.

7 Appendix

7.1 Appendix A Connectors and Media

2.5GBASE-T/1000BASE-T/100BASE-TX/10Base-T

The 2.5GBASE-T/1000BASE-T/100BASE-TX/10BASE-T is a 10/100/1000Mbps auto-negotiation port that supports auto MDI/MDIX.

Compliant with IEEE 802.3bz, 2.5GBASE-T requires 100-ohm CAT5e UTP or STP (STP is recommended) with a maximum distance of 100 meters (328 feet).

Compliant with IEEE 802.3ab, 1000BASE-T requires 100-ohm CAT5 or CAT5e UTP or STP (STP is recommended) with a maximum distance of 100 meters (328 feet).

2.5GBASE-T/1000BASE-T requires all four pairs of wires be connected for data transmission, as shown in Figure 7-1.

Figure 7-1 2.5GBASE-T/1000BASE-T Connection

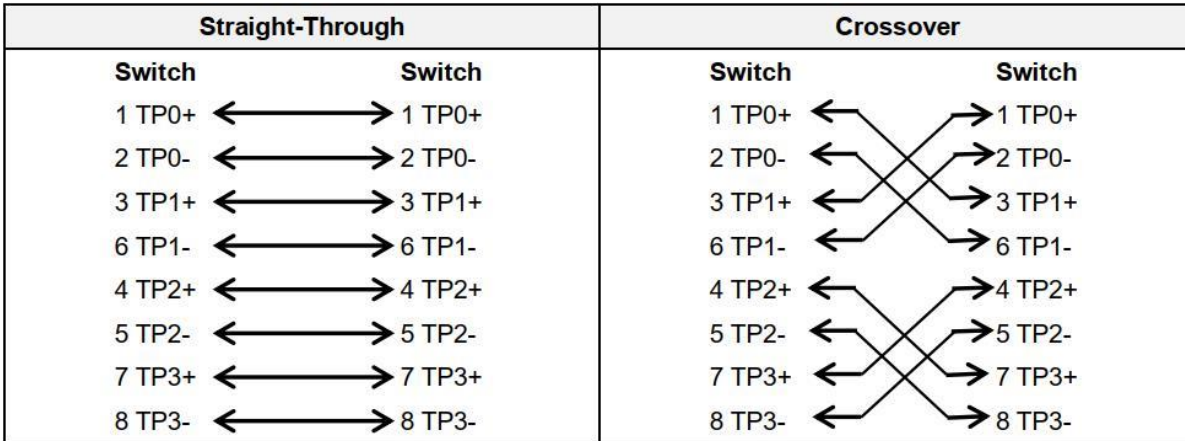

100BASE-TX/10BASE-T uses Category 3, 4, 5 100-ohm UTP/STP and 100BASE-T uses Category 5 100-ohm UTP/STP for connections. Both support a maximum length of 100 meters. Figure 7-2 shows 100BASE-TX/10BASE-T pin assignments.

Figure 7-2 100BASE-TX/10BASE-T Pin Assignments

Pin	Socket	Plug
1	Input Receive Data+	Output Transmit Data+
2	Input Receive Data-	Output Transmit Data-
3	Output Transmit Data+	Input Receive Data+
6	Output Transmit Data-	Input Receive Data-
4,5,7,8	Not used	Not used

Figure 7-3 shows wiring of straight-through and crossover cables for 100BASE-TX/10BASE-T.

Figure 7-3 100BASE-TX/10BASE-T Connection

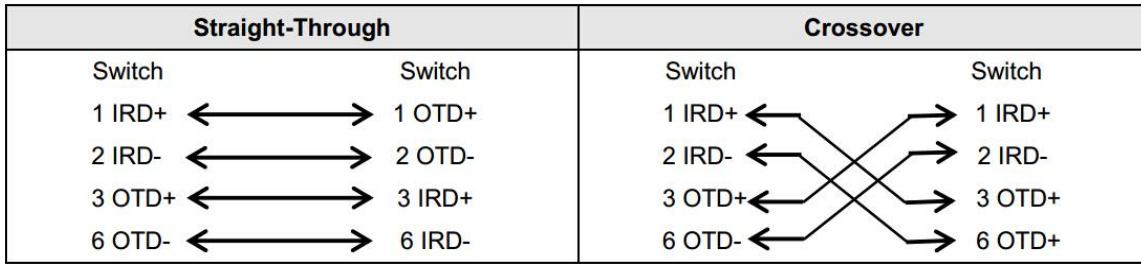

7.2 Appendix B Cabling Recommendations

During installation, route cable bundles upward or downward along the sides of the rack depending on the actual situation in the equipment room. All cable connectors should be placed at the bottom of the cabinet rather than be exposed outside of the cabinet. Power cords should be routed upward or downward beside the cabinet close to the location of the DC power distribution cabinet, AC power outlet, or lightning protection box.

7.2.1 Requirements for Minimum Cable Bend Radius

- The minimum bend radius of a power, communication or flat cable should be 5 times the overall diameter of the cable. If the cable is constantly bent, plugged, or unplugged, the bend radius should be 7 times the overall diameter.
- The minimum bend radius of a coaxial cable should be 7 times the overall diameter of the cable. If the cable is constantly bent, plugged, or unplugged, the bend radius should be 10 times the overall diameter.
- The minimum bend radius of a high-speed cable, such as an SFP+ cable should be 5 times the overall diameter of the cable. If the cable is constantly bent, plugged, or unplugged, the bend radius should be 10 times the overall diameter.

7.2.2 Precautions for Cable Bundling

- Before bundling cables, correctly mark labels and stick the labels to cables where appropriate.
- Cables should be neatly and properly bundled, as shown in Figure 7-4.

Figure 7-4 Bundling Cables

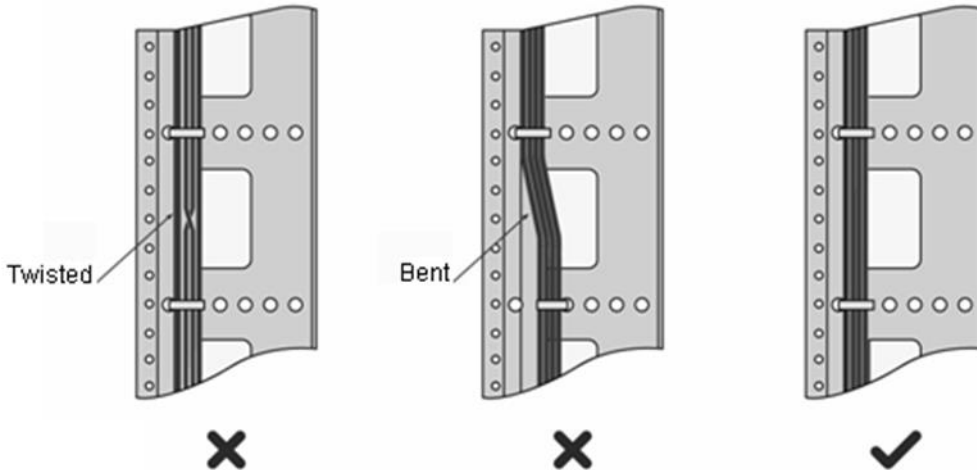

- Route and bundle power, signal, ground cables separately. When the cables are close to each other, cross them. When power cables run parallel to signal cables, the distance between them must be greater than 30mm.
- All cable trays and their accessories shall be smooth and free from sharp edges.
- Holes in metal, through which cables pass shall have smooth, well-rounded surfaces or be protected with insulating bushings.
- Use proper cable ties to bind cables together. Do not tie two or more cable ties to bind cables.
- Cut off excess cable tie cleanly with no sharp edges after bundling cables, as shown in Figure 7-5.

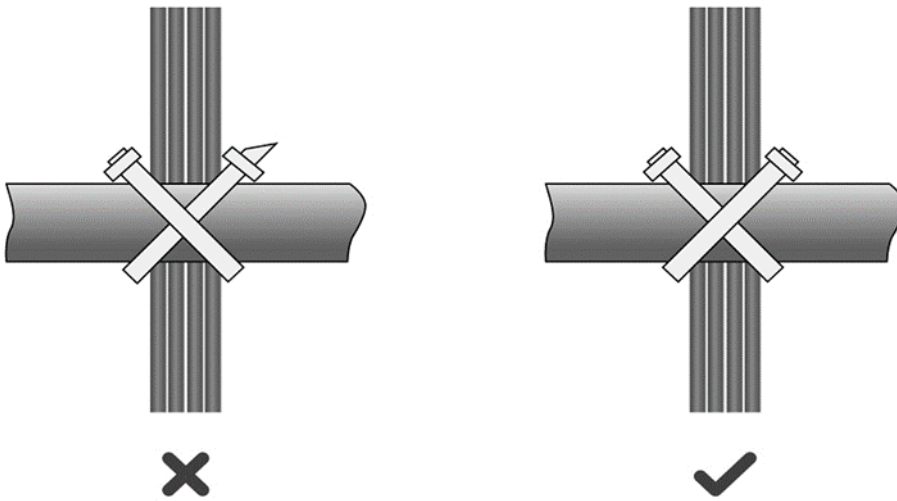
Figure 7-5 Cutting off Excess Cable Tie

- If cables are to be bent, bind them first but do not tie cable ties within the bend to avoid stress on the cables, which may otherwise cause the wires inside to break, as shown in Figure 7-6.

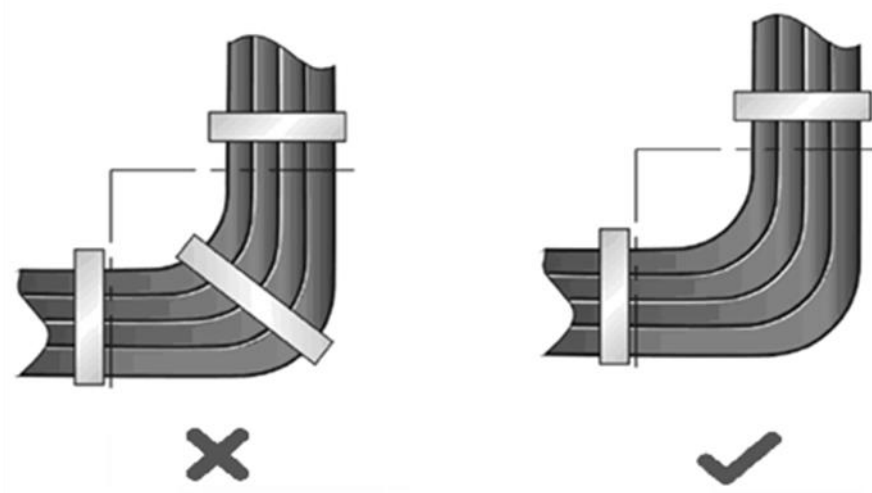
Figure 7-6 Do Not Tie Cable Ties within the Bend

- Wrap up unnecessary or excess cables and bind them to the appropriate rack position, where device operation is not affected and no damages occur to the device and cables during debugging.
- Do not bind power cords to the rails for moving parts.
- Leave a certain length of the cable connecting moving parts, such as the ground wire of the cabinet door, to avoid stress on the cable; When moving parts are in place, ensure the excess cable length shall not contact heat sources, sharp corners, or edges. If heat sources are unavoidable, use high-temperature cables instead.
- When using screws to fasten cable lugs, the bolts or nuts shall be tightened and prevented from loosening, as shown in Figure 7-7.

Figure 7-7 Fastening Cable Lugs

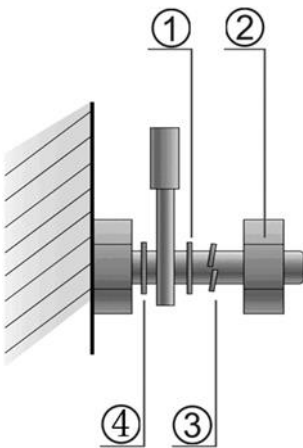

Note:	1. Flat washer	2. Spring washer
	3. Nut	4. Flat washer

- When using a stiff cable, fix it near the cable lug to avoid stress on the lug and cable.
- Do not use self-tapping screws to fasten terminals.
- Bundle cables of the same type and running in the same direction into groups. Keep cables clean and straight.
- Cables shall be tied according to the following table.

Diameter of Cable Bundle	Distance between Every Binding Point
10 mm (0.39 in.)	80 mm to 150 mm (3.15 in. to 5.91 in.)
10 mm to 30 mm (0.39 in. to 1.18 in.)	150 mm to 200 mm (5.91 in. to 7.87 in.)
30 mm (1.18 in.)	200 mm to 300 mm (7.87 in. to 11.81 in.)

- Do not tie knots for cables or cable bundles.
- The metal parts of the cold-pressed terminal blocks, such as air circuit breakers, shall not be exposed outside of the blocks.