

## THC-T257-LMS 3K Dual Light Audio Fixed Turret Camera



- High quality imaging with 3K, 2960 × 1665 resolution
- Fixed focal lens, 2.8 mm and 3.6 mm optional
- Up to 40 m IR distance for bright night imaging
- Up to 20 m white light distance for bright night imaging
- One port for four switchable signals (TVI/AHD/CVI/CVBS )
- Water and dust resistant (IP66)
- High quality audio with audio over coaxial cable, built-in microphone

## ▪ Specification

Camera	
Image Sensor	3K CMOS
Max. Resolution	2960 (H) × 1665 (V)
Min. Illumination	0.01 Lux @ (F2.0, AGC ON), 0 Lux with IR
Shutter Time	PAL: 1/25 s to 1/50,000 s; NTSC: 1/30 s to 1/50,000 s
Day & Night	ICR
Angle Adjustment	Pan: 0 to 360°, Tilt: 0 to 75°, Rotate: 0 to 360°
Signal System	PAL/NTSC
Lens	
Lens Type	2.8 mm and 3.6 mm fixed focal lens
Focal Length & FOV	2.8 mm, horizontal FOV: 104.9°, vertical FOV: 67.3°, diagonal FOV: 129.8° 3.6 mm, horizontal FOV: 81.3°, vertical FOV: 50.7°, diagonal FOV: 102.4°
Lens Mount	M12
Illuminator	
Supplement Light Type	White Light,IR
Supplement Light Range	IR : up to 40 m White Light : up to 20 m
Image	
Image Settings	Brightness, Sharpness, Smart IR
Frame Rate	TVI: 3K @20 fps, 4 MP @25 fps/30 fps, 1080p @25 fps/30 fps AHD: 5 MP @20 fps, 4 MP @25 fps/30 fps CVI: 4 MP @25 fps/30 fps CVBS: PAL/NTSC
Day/Night Mode	Auto/Color/BW (Black and White)
Wide Dynamic Range (WDR)	Digital WDR
Image Enhancement	DWDR/BLC/HLC/Global
White Balance	Auto/Manual
AGC	Yes
Interface	
Video Output	Switchable TVI/AHD/CVI/CVBS
Built-in Microphone	Yes
General	
Material	Body: metal Enclosure: metal
Dimension	Ø127.9 mm × 97.8 mm (Ø5.04" × 3.85")
Weight	Approx. 476 g (0.75 lb.)
Operating Condition	-40 °C to 60 °C (-40 °F to 140 °F). Humidity: 90% or less (non-condensation)
Communication	HIKVISION-C
Language	English
Power Supply	12 VDC ± 25% *You are recommended to use one power adapter to supply the power for one camera.
Consumption	Max. 3.3 W

**Approval**

Protection	IP66
------------	------

▪ **Available Model**

THC-T257-LMS



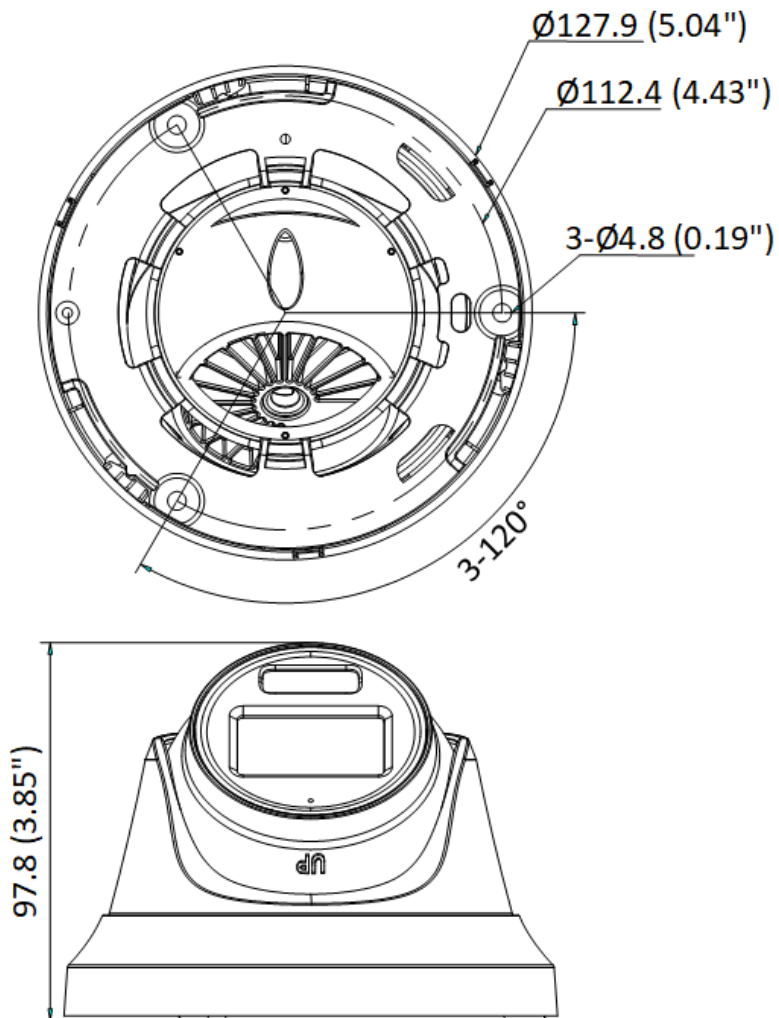





▪ **Dimension**



Unit: mm (inch)

▪ **Accessory**

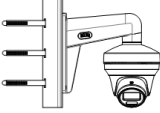
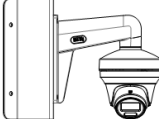
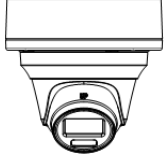
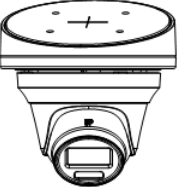
▪Optional

<b>DS-1272ZJ-110-TRS</b> <b>Wall mount</b>	<b>DS-1275ZJ-SUS</b> <b>Vertical pole mount</b>	<b>DS-1276ZJ-SUS</b> <b>Corner mount</b>	<b>DS-1280ZJ-S</b> <b>Junction box</b>	<b>DS-1281ZJ-S</b> <b>Inclined ceiling mount</b>
				
				
<b>DS-1272ZJ-110-TRS</b> <b>(GREY)#UK</b> <b>Junction box</b>	<b>DS-1275ZJ-SUS(Grey)#UK</b> <b>Junction box</b>			
				



## HiLook

### Headquarters

No.555 Qianmo Road, Binjiang District,  
Hangzhou 310051, China  
T +86-571-8807-5998  
Technical Support: support@hikvision.com

Follow us on social media to get the latest product and solution information.

