

# DH-IPC-HDBW3849R-ZAS-IL

## 8MP Smart Dual Light Vari-focal Dome WizSense Network Camera



Launched by Dahua Technology, WizSense is a series of AI products and solutions that adopt independent AI chip and deep learning algorithm. It focuses on human and vehicle with high accuracy, enabling users to fast act on defined targets. Based on Dahua's advanced technologies, WizSense provides intelligent, simple and inclusive products and solutions.

### Series Overview

With advanced deep learning algorithm, Dahua WizSense 3 Series network camera supports intelligent functions, such as perimeter protection and smart motion detection. With starlight technology, this series camera provides a better image effect in the condition of low illuminance.

### Functions

#### Xinghan Large-Scale AI Models-Vision

Xinghan Large-Scale AI Models-Vision seamlessly expands the storage and operational capacity of algorithmic models through the powerful integration of edge AI model algorithms and NPU computing power. Engineered with a lightweight transformer architecture and enhanced by model distillation and quantization techniques, it optimizes the computing power consumption of ViT operators. This enables the system to collaborate on multiple tasks simultaneously through joint inference between small and large models optimized for edge devices.

#### SMD 4.0

Dahua Smart Motion Detection technology works with intelligent algorithms to classify targets that trigger motion detection alarms. It filters out objects that are not targets, such as small and large animals, to avoid triggering false alarms. With an AI NVR, Quick Pick technology becomes available, allowing you to easily search for and pick out human and vehicle targets from SMD event videos, prioritizing the highest matches.

#### Perimeter Protection

With deep learning algorithm, Dahua Perimeter Protection technology can recognize human and vehicle accurately. In restricted area (such as pedestrian area and vehicle area), the false alarms of intelligent detection based on target type (such as tripwire, intrusion) are largely reduced.

#### Smart H.265+ & Smart H.264+

With advanced scene-adaptive rate control algorithm, Dahua smart encoding technology realizes the higher encoding efficiency than H.265 and H.264, provides high-quality video, and reduces the cost of storage and transmission.

- 8-MP 1/2.7" CMOS image sensor, low luminance, and high definition image.
- Outputs max. 8 MP (3840 × 2160)@25/30 fps.
- H.265 codec, high compression rate, ultra-low bit rate.
- Built-in multi-core light, the max. IR distance is 50 m and the max. warm light distance is 50 m.
- ROI, SMART H.264+/H.265+, AI H.264/H.265, flexible coding, applicable to various bandwidth and storage environments.
- Rotation mode, WDR, 3D NR, HLC, BLC, digital watermarking, applicable to various monitoring scenes.
- Intelligent monitoring: Intrusion, tripwire (the two function support the classification and accurate detection of vehicle and human), stay detection, loitering detection, face detection (full image).
- Abnormality detection: Motion detection, video tampering, scene changing, audio detection, no SD card, SD card full, SD card error, network disconnection, IP conflict, illegal access, and voltage detection.
- Alarm: 1 in, 1 out; audio: 1 in, 1 out; supports max. 512 G Micro SD card; built-in Mic.
- 12 VDC/PoE power supply.
- IP67, IK10 protection.
- SMD 4.0.
- Supports AI SSA.
- SMD area can be set in warm light areas that support triggering alarms.

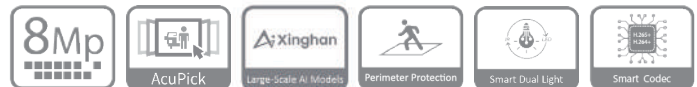

#### Smart Dual Light

Dahua Smart Dual Light technology adopts smart algorithm to detect targets. Usually, the IR illuminator is on at night; when the target appears in the monitoring area, the white light is on, and the camera records the full-color video and information of key events. That is, the camera links snapshot and video with full-color image. When the target is out of the monitoring area, the white light is off and the IR illuminator is on, which reduces light pollution efficiently.

#### Protection (IP67, IK10, Wide Voltage)

IP67: The camera passes a series of strict test on dust and soak. It has dust-proof function, and the enclosure can work normally after soaking in 1 m deep water for 30 minutes.

IK10: The enclosure can stand the punch more than 5 times from a 5 kg hammer falling from a height of 40 cm (Impact energy is 20J).

Wide voltage: The camera allows  $\pm 30\%$  (for some power supplies) input voltage tolerance (wide voltage range), and it is widely applied to outdoor environment with instable voltage.

**Technical Specification**

**Camera**

Image Sensor	1/2.7" CMOS
Max. Resolution	3840 (H) × 2160 (V)
ROM	256 MB
RAM	1 GB
Scanning System	Progressive
Electronic Shutter Speed	Auto/Manual 1/3 s–1/100,000 s
Min. Illumination	0.007 lux@F1.4 (Color, 30 IRE) 0.0007 lux@F1.4 (B/W, 30 IRE) 0 lux (Illuminator on)
S/N Ratio	>56 dB
Illumination Distance	Up to 50 m (164.04 ft) (IR) Up to 50 m (164.04 ft) (Warm light)
Illuminator On/Off Control	Auto; Manual
Illuminator Number	4 (Multi-core (IR + warm) light)
Angle Adjustment	Pan: 0°–355°; Tilt: 0°–80°; Rotation: 0°–355°

**Lens**

Lens Type	Motorized vari-focal
Lens Mount	φ14
Focal Length	2.7 mm–13.5 mm
Max. Aperture	F1.4
Field of View	H: 114°–32°; V: 58°–17°; D: 138°–36°
Iris Control	Fixed
Close Focus Distance	0.1 m (0.33 ft)

DORI Distance	Lens	Detect	Observe	Recognize	Identify
	W	85.3 m (279.86 ft)	34.0 m (111.55 ft)	17.1 m (56.10 ft)	8.5 m (27.89 ft)
	T	280.0 m (918.64 ft)	112.0 m (367.45 ft)	56.0 m (183.73 ft)	28.0 m (91.86 ft)

\*DORI (Detect, Observe, Recognize, Identify) is a standard system (EN-62676-4) for defining the ability of a person viewing the video to distinguish persons or objects within a covered area. The numbers in this table do not reflect intelligent function distances. For intelligent function distances, refer to installation and commissioning manual/project design tool.

**Intelligence**

IVS (Perimeter Protection)	Intrusion, tripwire (the two functions support the classification and accurate detection of vehicle and human), stay detection, loitering detection.
Face Detection(Full Image)	Face detection; snapshot; snapshot optimization; optimal face snapshot upload; face enhancement; face snapshot set as face or one-inch photo; snapshot strategies (real-time snapshot, quality priority and optimization snapshot); face angle filter; optimization time setting.
SMD	SMD 4.0
AcuPick	Uses deep learning algorithms and works with back-end devices to accurately match targets, such as people and motor vehicles, and search through live and recorded videos to quickly locate targets.

AI SSA	Adopt deep learning algorithms to adjust the parameters of the image to suit the conditions
Smart Search	Work together with Smart NVR to perform refine intelligent search, event extraction and merging to event videos
<b>Video</b>	
Video Compression	H.265; H.264; H.264H; H.264B; MJPEG (only supported by the sub stream)
AI Coding	AI H.265; AI H.264 *includes SmartCodec Technology,Smart H.264+ /H.265+
Video Frame Rate	Main stream: 3840 × 2160@(1 fps–25/30 fps) Sub stream: 1920 × 1080@(1 fps–25/30 fps) Third stream: 1920 × 1080@(1 fps–25/30 fps) *The values above are the max. frame rates of each stream; for multiple streams, the values will be subjected to the total encoding capacity.
Stream Capability	3 streams
Resolution	8M (3840 × 2160); 6M (3200 × 1800); 5M (3072 × 1728); 4M (2688 × 1520/2560 × 1440); 3M (2304 × 1296); 1080p (1920 × 1080); 720p (1280 × 720); D1 (704 × 576/704 × 480); VGA (640 × 480); CIF (352 × 288/352 × 240)
Bit Rate Control	VBR; CBR; ABR
Video Bit Rate	H.264: 3 kbps–16384 kbps H.265: 3 kbps–16384 kbps
Day/Night	Auto (ICR)/Color/B/W
BLC	Yes
HLC	Yes
WDR	120 dB
Scene Self-adaptation (SSA)	Yes
White Balance	Auto; natural; street lamp; outdoor; manual; regional custom
Gain Control	Auto
Noise Reduction	3D NR
Motion Detection	OFF/ON (4 areas, rectangular)
Image Stabilization	Electronic Image Stabilization (EIS)
Region of Interest (RoI)	Yes (4 areas)
Smart Illumination	Yes
Smart Dual Light	Yes
Defog	Yes
AFSA	Yes
Image Rotation	0°/90°/180°/270° (support 90°/270° with 2688 × 1520 resolution and lower)
Mirror	Yes
Privacy Masking	8 areas
<b>Audio</b>	
Built-in Mic	Yes, built-in Mic
Audio Compression	G.711a; G.711Mu; PCM; G.726; G.723

**Alarm**

Alarm Event	No SD card; SD card full; SD card error; network disconnection; IP conflict; illegal access; motion detection; video tampering; tripwire; intrusion; stay detection; loitering detection; face detection (full image); scene changing; audio detection; voltage detection; defocus detection; external alarm; SMD; security exception
-------------	---

**Network**

Network Port	RJ-45 (10/100 Base-T)
SDK and API	Yes
Network Protocol	IPv4; IPv6; HTTP; TCP; UDP; ARP; RTP; RTSP; RTCP; RTMP; SMTP; FTP; SFTP; DHCP; DNS; DDNS; QoS; UPnP; NTP; Multicast; ICMP; IGMP; NFS; SAMBA; PPPoE; SNMP; P2P
Interoperability	ONVIF (Profile S & Profile G & Profile T & Profile M); CGI
User/Host	20 (Total bandwidth: 64 M)
Storage	FTP; SFTP; Micro SD card (support max. 512 G); NAS
Browser	IE: IE11 Chrome Firefox
Management Software	SmartPSS Lite; DSS; DMSS
Mobile Client	IOS; Android
Security	Digest; WSSE; Account lockout; Security logs; IP/MAC filtering; Generation and importing of X.509 certification; syslog; HTTPS; 802.1x; Trusted boot; Trusted execution; Trusted upgrade; Session security; Security warning

**Certification**

Certifications	CE-LVD: EN62368-1; CE-EMC: Electromagnetic Compatibility Directive 2014/30/EU
----------------	--

**Port**

Audio Input	1 channel (RCA port)
Audio Output	1 channel (RCA port)
Alarm Input	1 channel in: wet contact, 5 mA 3 V–5 VDC
Alarm Output	1 channel out: wet contact, 300 mA 12 VDC

**Power**

Power Supply	12 VDC/PoE (802.3af)
Dual Power Backup	When the power adapter and PoE provide power at the same time, disconnect one of them. The device will continue to work, but will not restart.
Power Consumption	Basic: 3.3 W (12 VDC); 4.0 W (PoE) Max. (H.265 + WDR + warm light + intelligence on): 9.2 W (12 VDC); 11.3 W (PoE)

**Environment**

Operating Temperature	-30 °C to +60 °C (-22 °F to +140 °F)
Operating Humidity	≤95% (RH), non-condensing
Storage Temperature	-40 °C to +60 °C (-40 °F to +140 °F)
Storage Humidity	≤95% (RH), non-condensing
Protection	IP67; IK10

**Structure**

Casing	Metal
--------	-------











Product Dimensions	94.0 mm × Φ122.0 mm (3.70" × Φ4.80")
Net Weight	560 g (1.23 lb)
Gross Weight	740 g (1.63 lb)

**Ordering Information**

Type	Model	Description	
8MP Camera	DH-IPC-HDBW3849R-ZAS-IL	8MP Smart Dual Light Vari-focal Dome WizSense Network Camera	
	Accessories (Optional)	DH-PFA137	Junction Box Bracket
		DH-PFA109	Mount Adapter
		DH-PFB220C	Ceiling Mount Bracket
		DH-PFB5203C	In Ceiling Mount Bracket
		DH-PFB206W	Wall Mount
		DH-PFA156	Pole Mount
		DH-PFM321-EN	DC12V 1A power adapter
		DH-PFM321D-EN	DC12V 1A power adapter
		DH-PFM320D-EN	DC12V 2A power adapter
PFM900-E		Integrated Mount Tester	
DHI-TF-P100/512GB	MicroSD Card		

**Accessories**

Optional:

		
DH-PFA137 Junction Box Bracket	DH-PFA109 Mount Adapter	DH-PFB220C Corner Mount Bracket
		
DH-PFB5203C In Ceiling Mount Bracket	DH-PFB206W Wall Mount	DH-PFA156 Pole Mount
		
DH-PFM321-EN DC12V 1A power adapter	DH-PFM321D-EN DC12V 1A power adapter	DH-PFM320D-EN DC12V 2A power adapter
		
PFM900-E Integrated Mount Tester	DHI-TF-P100/512GB MicroSD Card	

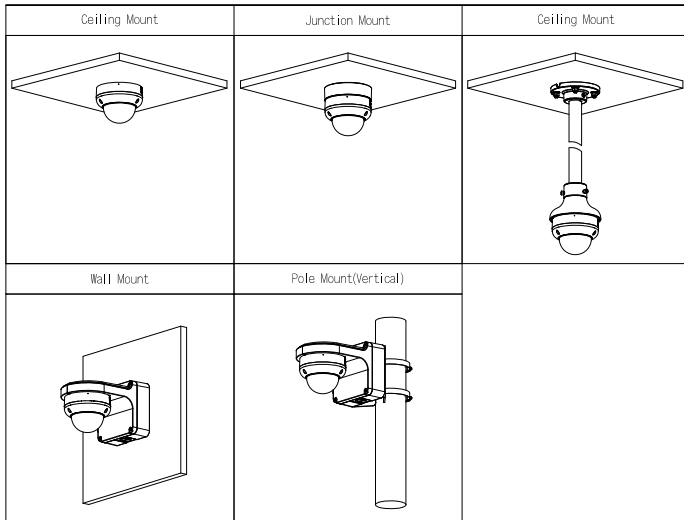

**Dimensions (mm[inch])**

